

RTX3 Wireless Expansion Module V5.2

P ▲ R ▲ D O X™



Reference and Installation Manual

Table of Contents

Specifications.....	4
Hardware Compatibility.....	4
Overview.....	5
Description.....	5
Features.....	5
Installation.....	7
Antenna Installation	8
System Reset	8
LED Feedback	9
Programming	10
Programming for Imperial	10
Programming for Spectra SP Series.....	10
Programming for EVO	11
Programming for Esprit and Stand Alone	17
Stand Alone Use.....	20
Firmware Upgrade	20
Index.....	21

Specifications

Power input voltage:	12Vdc
Frequency:	433MHz or 868MHz
Sensitivity:	-120 dBm
Current consumption:	50 mA
Dimensions and Weight:	15cm x 16cm x 3cm (6in x 6.5in x 1.1in) / 24g
Operating temperature:	0°C to 49°C (32°F to 120°F)
Humidity:	5 - 90%
PGM outputs:	PGM1 and PGM2 - 150mA PGM transistor outputs PGM3 - form C relay output rated at 5A/28Vdc, N.O./N.C. (PGM4 optional)
Range:	Refer to the appropriate transmitter <i>Instructions</i>
Other:	Di-pole antenna; Error Correction Algorithm
Approvals:	EN50131-3: Security Grade 2, Environmental Class II, Certification Body Intertek. For the latest information on product approvals, visit our website at paradox.com .

Hardware Compatibility

	Imperial	EVO	Spectra SP	Esprit	Stand Alone
Zones	32	32	32	-	32
Remotes	999	32/96/999	32	32	32
Remote Type	REM1 RAC1 REM2 RAC2 REM3 REM15	REM1 RAC1 REM2 RAC2 REM3 REM15	REM1 RAC1 REM2 RAC2 REM3 REM15	REM1 REM1 5	REM1 REM15
Wireless PGMs	-	8	16	-	-
Wireless Keypads	-	-	8	-	-
Wireless Siren	-	-	4	-	-
Wireless Repeater	-	-	2	-	-
PX8 Output Module	-	-	-	-	4

Chapter 1: Overview

This chapter provides an overview of the RTX3 Wireless Expansion Module. It covers the package contents provided with your RTX module, the system features, and an overview of the RTX3 components.

Description

The RTX3 is a 2-way, 32 zone wireless expansion module which enables Imperial, DGP/EVO, Spectra SP Series or Esprit control panels to support wireless hardware such as motion detectors and remote controls.

Included Items: Antenna
Required/Optional Items: <ul style="list-style-type: none">• Mounting hardware• Optional 12Vdc external power supply (PS27D / PS17)
Compatibility: <ul style="list-style-type: none">• Imperial V32 panels• EVO / DGP panels• Spectra SP Series panels• Esprit panels

Features

- Up to 32 wireless zones
- Support for REM1 / REM2 / REM3 / REM15 / RAC1 / RAC2 remote controls
- Support for wireless PGMs (EVO / SP Series only)
- Support for all Magellan transmitters including 2WPGM
- Support for two RPT1 and eight K32RF / K37 (SP Series only)
- Support for SR150 Wireless Siren and RPT1 Wireless Repeater (SP Series only)
- Support for PX8 Output Module
- In-field firmware upgradable through WinLoad via serial or 4-wire connection
- RF jamming supervision
- Low battery, tamper and check-in supervision
- Transmitter signal strength display
- 3 PGM outputs and 1 optional output (not available on Imperial panels)
- Noise level test and indicator

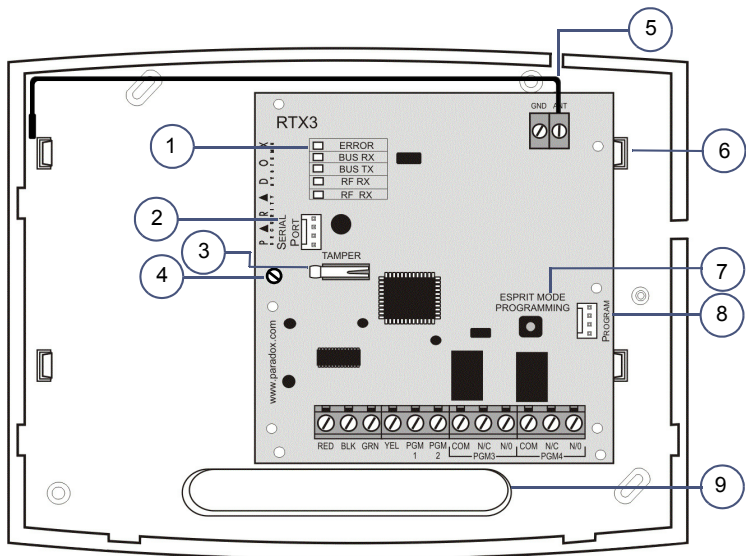

1. LED display
(see *LED Feedback* on page 9)
2. Firmware upgrade serial connection (see *Firmware Upgrade* on page 20)
3. Anti-tamper switch
4. PCB screw
5. Antenna
6. Mounting clips

7. Esprit Mode Programming button:
Press to enter programming mode in Esprit mode (see *Programming for Esprit and Stand Alone* on page 17). Also used for system reset (see *Antenna Installation* on page 8).
8. Connect the Esprit 636/646 LED keypad to the "Program" connector to program in Esprit and Stand Alone mode.
9. Wiring slot

Chapter 2: Installation

This chapter guides you through the steps required to connect the RTX3 Wireless Expansion Module.

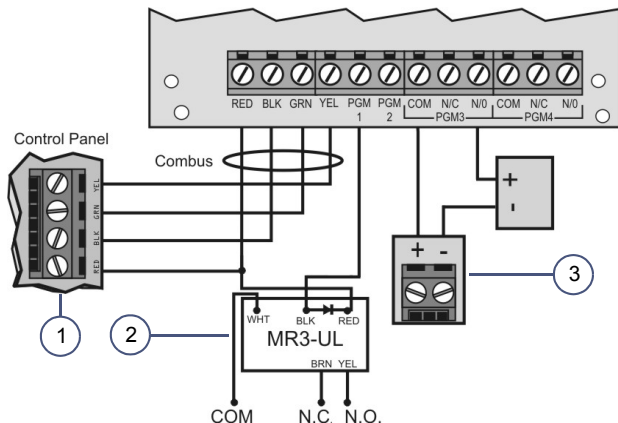

1. Control panel Combus connection.

NOTE: If you are using the RTX3 as a stand-alone device, connect an external 12Vdc power supply to the RED and BLK terminals. Battery backup is recommended.

2. If the current draw exceeds 150mA on PGM1 or PGM2, use a relay. Connect the RTX3's RED connector to the relay's RED connector, and the PGM connector (PGM1 or PGM2) to the relay's BLK connector.
3. Connect PGM3 and PGM4 to external power supplies if you need additional power. A PS-817 is recommended. Connect the PGM's N/O connector to the external power supply's "+" connection. Connect the power supply's "-" connector to the device's "-" connector. Connect the PGM's COM connector to the device's "+" connector.

NOTE: Write down the serial number of all wireless modules to be used with the RTX3. If this installation replaces another RTX3, make sure the programming can be transferred.

Antenna Installation

Secure the antenna (433 MHz antenna shown) to the ANT terminal connector.

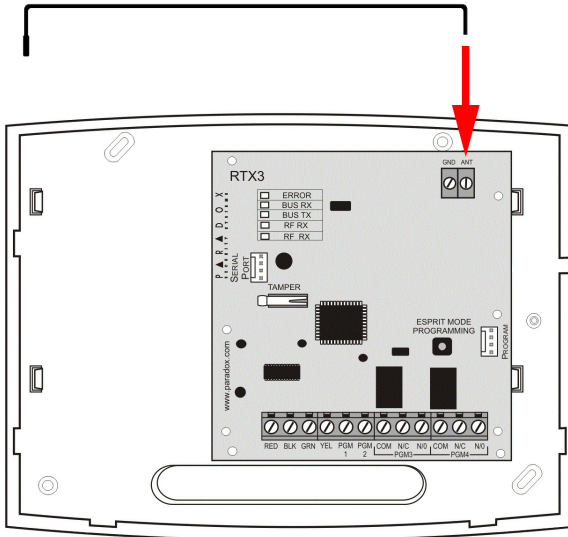



System Reset

The system reset feature only functions during the first 30 seconds after RTX3 power up.





To Reset the System

1. Press and hold the Programming button for 5 seconds, the BUS RX LED flashes.
2. Release the button and press it again while the LED flashes to reset the module to its default values.













LED Feedback

Legend	
R = Red	 = Off
G = Green	 = On
Y = Yellow	 = Flashing

All Panels

ERROR
 Problem with the module
BUS RX
 Receiving from panel
BUS TX
 Transmitting to panel
RF RX
 Receiving wireless
RF TX
 Transmitting wireless

EVO and SP Series only

ERROR	 Com fail: GRN/YEL
BUS RX	 short / no data
BUS TX	
ERROR	 Com fail: too many
BUS RX	 modules / wrong data
BUS TX	
ERROR	 Com fail: GRN/
BUS RX	 YEL reversed
BUS TX	
ERROR	 Combus power
BUS RX	 too low
BUS TX	

Chapter 3: Programming

This chapter provides programming instructions for Imperial, Spectra SP Series, EVO, Esprit, and stand alone installations.

Programming for Imperial

When connected to an Imperial panel, all RTX3 settings are programmed using BabyWare. For more detailed instructions on using BabyWare and programming remotes, refer to the *Imperial System Guide*.

To Program an RTX3 for an Imperial System

1. When BabyWare is communicating with the V32 controller and an RTX3 module is connected to the Multibus, it automatically appears in the Modules display area. To view the Modules display area, click the **Modules** toggle button. Alternatively, you may wish to add a module to BabyWare before the module is physically connected to the system. Click the **Add Item** button and add the RTX3 from the **Zone Expansion Modules** list.
2. When the RTX3 is added to the system, double-click the module's icon. The RTX3 Programming window opens.
3. From the RTX3 Programming window, configure Input Setup and Input options. Click **OK**.

Programming for Spectra SP Series

When connected to a Spectra SP series panel, the wireless settings are programmed using control panel programming sections. Refer to the panel's *Programming Guide*.

NOTE: Programming for a Spectra SP series system requires K32 or K10V/H keypads version 2.0 or higher.

NOTE: Only one RTX3 module can be connected to a Spectra SP Series panel.

Programming for EVO

When connected to an EVO panel, the wireless settings are programmed in Module Programming Mode.

To Enter Module Programming Mode

1. Press and hold the **[0]** key.
2. Enter your **[INSTALLER CODE]**.
3. Enter section **[4003]**.
4. Enter the module's **[SERIAL NUMBER]**
5. Enter the required **[DATA]**.

NOTE: When used without a K641 or K641R keypad, enable EVO option **[1]** in section **[3029]**.

After Programming for EVO

Program the zones, PGMs, and remotes into the EVO panel. Refer to EVO section **[3034]** and RTX3 section **[001]*** options **[2]** and **[3]** for wireless transmitter supervision options.

** For instructions on entering 3-digit RTX3 section numbers, see RTX3 Programming Sections for EVO on page 12.*

RTX3 Programming Sections for EVO

Section	Feature	Details
[001]	<i>RTX3 options</i>	
	Option [1] Low battery supervision	For RTX3 version 1.5 and higher, this option is always On (default: On).
	Option [2] Check-in supervision	default: Off
	Option [3] Check-in supervision time interval	Off = 24 hours (default) On = 80 minutes
	Option [4] RF Jamming supervision	default: Off
	Option [5] On-board module tamper supervision	default: Off
	Option [6] PGM1 initial state	Off = Normally Open (default) On = Normally Closed
	Option [7] PGM2 initial state	Off = Normally Open (default) On = Normally Closed
	Option [8] Transmitter tamper signal	Off = RTX3 ignores tamper signal (default) On = RTX3 reports tamper signal
[002]	<i>Remote control options</i>	
	Option [1] REM2 Visual and auditory feedback compatibility options*	Off = Old visual and auditory feedback (Supported by REM2 V2.00 or lower) On = New visual and auditory feedback (default) (Requires REM2 V2.01 or higher with K641 / K641R keypads)
[030]	<i>View transmitter, remote and PGM serial numbers</i>	To view a transmitter's 6-digit serial number, press and hold the transmitter's anti-tamper switch.

* The new visual and auditory feedback includes the following system statuses: stay armed, instant armed and exit delay. Other status feedback has not changed. Note that for REM2 versions 1.04 or older, stay arm, instant arm and exit delay statuses are not supported, and a rejection beep will be heard when the system is in these statuses.

Section	Feature	Details
[101] to [132]	<i>Assign wireless transmitters</i>	[101] = Zone Input 1 [132] = Zone Input 32 Enter 6-digit serial number or press and release the transmitter's tamper switch. To delete an assigned transmitter, enter 000000 as a serial number.
See text	<i>Remote controls</i>	To program remotes controls, refer to User Code and Remote Control Programming in the EVO Programming Guide or program remotes using WinLoad. NOTE: If programming REM1 / RAC1/ REM2 / RAC2 / REM15 remotes for a system that does not include a K641/K641R keypad, enable EVO option [1] in section [3029] and refer to "RTX3 Remote Programming for EVO - Without a K641/K641R Keypad" on page 16.
[601] to [632]	<i>Transmitter signal strength</i>	[601] = Zone input 1 [632] = Zone input 32 3 or less = weak (move transmitter) 4 to 10 = OK
[701] to [732]	<i>Current battery life</i>	[701] = Zone input 1 [732] = Zone input 32 View number of weeks the batteries have been in the transmitter.
[801] to [832]	<i>Previous battery life</i>	[801] = Zone input 1 [832] = Zone input 32 View number of weeks the previous batteries were in the transmitter.
[671] to [678]	<i>2WPGM signal strength</i>	[671] = PGM 1 [678] = PGM 8 3 or less = weak (move transmitter) 4 to 10 = OK

Section	Feature	Details
[901] to [908]	<i>Assign 2WPGMs</i>	[901] = PGM 1 [908] = PGM 8 Enter 6-digit serial number or press and release the transmitter's tamper switch. To delete an assigned 2WPGM, enter 000000 as a serial number. If a section between [901] to [904] is empty, the RTX3 will use the on-board PGM.
[910] to [989]	<i>PGM programming</i>	Program the Two-Way PGM activation event, deactivation event and PGM Delay options. Refer to <i>RTX3 PGM Options for EVO</i> .
[991]	<i>View two-way PGM tamper trouble</i>	PGM # in trouble will be displayed
[992]	<i>View two-way PGM supervision trouble</i>	PGM # in trouble will be displayed

RTX3 PGM Options for EVO

PGM Activation

PGM Number	Event Group	Feature Group	Start #	End #
PGM1	[910]	[911]	[912]	[913]
PGM2	[920]	[921]	[922]	[923]
PGM3	[930]	[931]	[932]	[933]
PGM4	[940]	[941]	[942]	[943]
PGM5	[950]	[951]	[952]	[953]
PGM6	[960]	[961]	[962]	[963]
PGM7	[970]	[971]	[972]	[973]
PGM8	[980]	[981]	[982]	[983]
Default Data	000	000	000	000

NOTE: For a complete list of events, refer to the PGM programming section of your DGP/EVO control panel's *Programming Guide*.

PGM Deactivation

PGM Number	Event Group	Feature Group	Start #	End
PGM1	[914]	[915]	[916]	[917]
PGM2	[924]	[925]	[926]	[927]
PGM3	[934]	[935]	[936]	[937]
PGM4	[944]	[945]	[946]	[947]
PGM5	[954]	[955]	[956]	[957]
PGM6	[964]	[965]	[966]	[967]
PGM7	[974]	[975]	[976]	[977]
PGM8	[984]	[985]	[986]	[987]
Default Data	000	000	000	000

NOTE: For a complete list of events, refer to the PGM programming section of your Digiplex or Digiplex EVO control panel's *Programming Guide*.

PGM Delay

PGM Number	Delay (000 to 255)	Options
PGM1	[918]	[919]
PGM2	[928]	[929]
PGM3	[938]	[939]
PGM4	[948]	[949]
PGM5	[958]	[959]
PGM6	[968]	[969]
PGM7	[978]	[979]
PGM8	[988]	[989]
Default Data	005	Off

The following options apply to sections [919], [929]... [989]:

Option [1]: PGM deactivation after:

See table on right

Option [2]: PGM base time:

On = Minutes

Off = Seconds (default)































Option [8]: Flexible PGM deactivation*:

See table on right

[1]	[8]	
Off	Off	Deactivation Event
Off	On	Deactivation Event
On	Off	PGM Timer
On	On	PGM Timer <u>or</u> Deactivation Event

* In order to use the "Flexible PGM deactivation" option (option [8]), the "PGM deactivation after option" (option [1]) must be On.

RTX3 Remote Programming for EVO - Without a K641/K641R Keypad

Section	Feature	Details																
[040] to [043]	<i>View or delete used remotes</i>	[040] = remotes 1 to 8 [043] = remotes 25 to 32 After entering the section, select which of the eight remote positions you wish to delete. Any remote position displaying “★” will be deleted when [ENTER] is pressed.																
[201] to [232]	<i>Assign remote controls to the system</i>	[201] = remote 01 [232] = remote 32 Enter the desired section and then press and hold a button on the remote control until you hear a confirmation beep.																
[301] to [332]	<i>Assign remotes controls to users</i>	Assign the remote controls to users by entering a user number (001 to 255) in the appropriate section (Users 001 to 255, section [301] = remote 01, section [332] = remote 32.)																
[401] to [432]	<i>Program or delete remote</i>	<p>[401] = remote 01 [432] = remote 32</p> <p>____ / ____ / ____ / ____ / ____ / ____ / ____ / ____ (default: 15000000)</p> <table style="width: 100%; border: none;"> <tr> <td style="text-align: center;"></td> <td style="text-align: center;"></td> <td style="text-align: center;"></td> <td style="text-align: center;"></td> <td style="text-align: center;">N/A</td> <td style="text-align: center;"></td> <td style="text-align: center;">N/A</td> <td style="text-align: center;">N/A</td> </tr> <tr> <td style="text-align: center;"></td> <td style="text-align: center;"></td> <td style="text-align: center;"></td> <td style="text-align: center;"></td> <td style="text-align: center;">N/A</td> <td style="text-align: center;"></td> <td style="text-align: center;">N/A</td> <td style="text-align: center;">N/A</td> </tr> </table> <p>[0] = Button disabled [1] = Regular arm [2] = Stay arm [3] = Instant arm [4] = Force arm [5] = Disarm [6] = Stay / instant disarm [7] = Panic 1 (Police) [CLEAR] = Exit without saving</p> <p>[8] = Panic 2 (non-medical) [9] = Panic 3 (fire) [STAY] = Smoke reset [FORCE] = Utility key 1 [ARM] = Utility key 2 [DISARM] = Utility key 3 [BYP] = Utility key 4 [MEM] = Utility key 5 [ENTER] = Save data</p>					N/A		N/A	N/A					N/A		N/A	N/A
				N/A		N/A	N/A											
				N/A		N/A	N/A											

















Programming for Esprit and Stand Alone





To enter programming mode with Esprit or in Stand Alone mode:

1. Connect an Esprit 636 or 646 to the "Program" connector.
2. Press the "Esprit Mode Programming" button.
3. Press **[ENTER]** on your Esprit keypad and enter the installer code (default: 757575).
4. Enter the desired section number.

Esprit Programming

Section	Feature	Details
[000]	<i>Installer code</i>	Set installer code (4 or 6 digits, default: 757575)
[004]	<i>PGM initial state</i>	
	Option [6] PGM1 initial state	Off = Normally open (default) On = Normally closed
	Option [7] PGM2 initial state	Off = Normally open (default) On = Normally closed
[301] to [332]	<i>User code assignment</i>	[301] = User 01 [332] = User 32 Assign a valid user code from the Esprit Panel into the RTX3. To delete a user code, press [2ND] and then [ENTER] .
[201] to [232]	<i>Remote control assignment</i>	[201] = Remote control 01 [232] = Remote control 32 Press [ENTER] . After the confirmation beep, press and hold any button on the remote until you hear two beeps. To delete a remote control, press [2ND] followed by [ENTER] .

Section	Feature	Details	
[401] to [432]	<i>Remote Control Button Options</i>		
	<div style="border: 1px solid black; padding: 5px; display: inline-block;"> [401] = remote control 01 [432] = remote control 32 </div>		
	Option [1]	Option [2]	Option [3] Definition*
	Off	Off	Off No Arm or Disarm
	On	Off	Off Button  = Regular Arm (default)
	Off	On	Off Button  = Regular Arm
	On	On	Off Button  = Regular Arm
			Button  = Regular Arm
	Off	Off	On Button  = Force Arm
	On	Off	On Button  = Force Arm
			Button  = Stay Arm
	Off	On	On Button  = Regular Arm
			Button  = Stay Arm
	On	On	On Button  = Stay Arm
	* Buttons used to arm the system are also used to disarm the system.		
	Option [4]	To select PGM, see section [011]	Enable button  for PGM activation (default = On)
	Option [5]	To select PGM, see section [012]	Enable button  for PGM activation (default = On)
	Option [6]	To select PGM, see section [013]	Enable button  for PGM activation (default = On)
	Option [7]	To select PGM, see section [014]	Enable button  for PGM activation (default = On)
	Option [8]		Enable button  +  for Panic Alarm (default = On)

Section	Feature	Details	
[011] to [014]	<i>PGM output activation</i> [011] = Remote Button  [012] = Remote Button  [013] = Remote Button  [014] = Remote Button 	Refer to section [401] to [432]	
	Option [1]	Activate PGM 1 output	Default On in section [011]
	Option [2]	Activate PGM 2 output	Default On in section [012]
	Option [3]	Activate PGM 3 output	Default On in section [013]
	Option [4]	Activate PGM 4 output	Default On in section [014]
[021] to [024]	<i>PGM latch / delay</i> [021] = PGM 1 [024] = PGM 4	(default)	
	Option [0]		Latched
	Option [1]		1 second
	Option [2]		5 seconds
	Option [3]		10 seconds
	Option [4]		20 seconds
	Option [5]		40 seconds
	Option [6]		60 seconds
	Option [7]		2 minutes
Option [8]	4 minutes		
[001]	<i>Code length</i>		
	Option [1]	Code length	On = 6-digit access code length (default) Off = 4-digit access code length
	Option [2]	Panic alarm	On = Panic alarm toggles PGM and panic alarm (default) Off = Panic alarm toggles the PGM

Section	Feature		Details
[002]	<i>PGM output on panic</i>		(default)
	Option [0]	No PGM output on panic alarm	
	Option [1]	Toggle PGM 1 on panic alarm	
	Option [2]	Toggle PGM 2 on panic alarm	
	Option [3]	Toggle PGM 3 on panic alarm	
	Option [4]	Toggle PGM 4 on panic alarm	
[003]	<i>RF lockout on panic</i>		(default)
	Option [0]	No RF signal lockout on panic alarm	
	Option [1]	30-second RF signal lockout on panic alarm	
	Option [2]	60-second RF signal lockout on panic alarm	
	Option [3]	90-second RF signal lockout on panic alarm	
	Option [4]	120-second RF signal lockout on panic alarm	

Stand Alone Use

The RTX3 can be used as a Stand Alone module. The programming sections are the same as when used with an Esprit with the following exceptions:

- In Stand Alone mode, section [001], option [1] and option [2] will not affect system use.
- Panic alarms can only be used to toggle PGMs on the RTX3 in Stand Alone mode.
- Sections [301] to [332] do not have to be programmed.

NOTE: To program wireless transmitters in Stand Alone mode, you must use a PX8 in conjunction with the RTX3. Refer to the PX8 Instructions for more information.

Firmware Upgrade

The RTX3 firmware can be upgraded using either a serial connection or a four-wire connection. For firmware upgrade instructions, refer to the Firmware Upgrade Instructions document which is available at paradox.com > Software > WinLoad. To upgrade an RTX3 on an Imperial system, refer to the RTX3 chapter in the *Imperial System Guide*.

Index

Sections

2WPGM	
<i>Assigning</i>	14
<i>Signal strength</i>	13

A

Antenna installation	8
Antennas	6
Anti-tamper switch	6
Approvals	4
Assign wireless transmitters	13

B

Battery life	13
--------------------	----

C

Check-in supervision	12
Check-in supervision time interval	12
Code length	19
Compatibility	4
Consumption	4
Current battery life	13
Current consumption	4

D

Dimensions	4
------------------	---

E

EN50131	4
Esprit	17
Esprit mode	6
EVO	11

F

Firmware upgrade	20
Frequency	4

I

Imperial	10
Input voltage	4
Installation	7

Installer code	17
----------------------	----

K

K641	11
------------	----

L

LED display	6
LED feedback	6, 9
Low battery supervision	12

M

Module programming mode (EVO)	11
Mounting clips	6

O

On-board module tamper supervision	12
Operating temperature	4

P

Panic alarm	19
PGM	
<i>Activation</i>	14
<i>Deactivation</i>	15
<i>Delay</i>	15
<i>initial state</i>	12, 17
<i>Latch / delay</i>	19
<i>Options for EVO</i>	14
<i>Output activation</i>	19
<i>output on panic</i>	20
<i>outputs</i>	4
<i>Programming</i>	14
<i>Supervision trouble</i>	14
<i>Tamper trouble</i>	14
Power input voltage	4
Previous battery life	13
Programming	10
Programming button	6

R

REM2 visual and auditory feedback	12
Remote control assignment	17
Remote control button options	18
Remote controls	13
Reset	8
RF Jamming supervision	12
RF lockout on panic	20

S

Sensitivity	4
Signal strength	13
Specifications	4
Spectra SP series	10
Stand alone	17, 20
System reset	8

T

Temperature	4
Transmitter signal strength	13
Transmitter tamper signal	12

U

User code assignment	17
----------------------------	----

V

View serial numbers	12
Voltage	4

W

Warranty	24
Wireless transmitter supervision options	11
Wiring slot	6

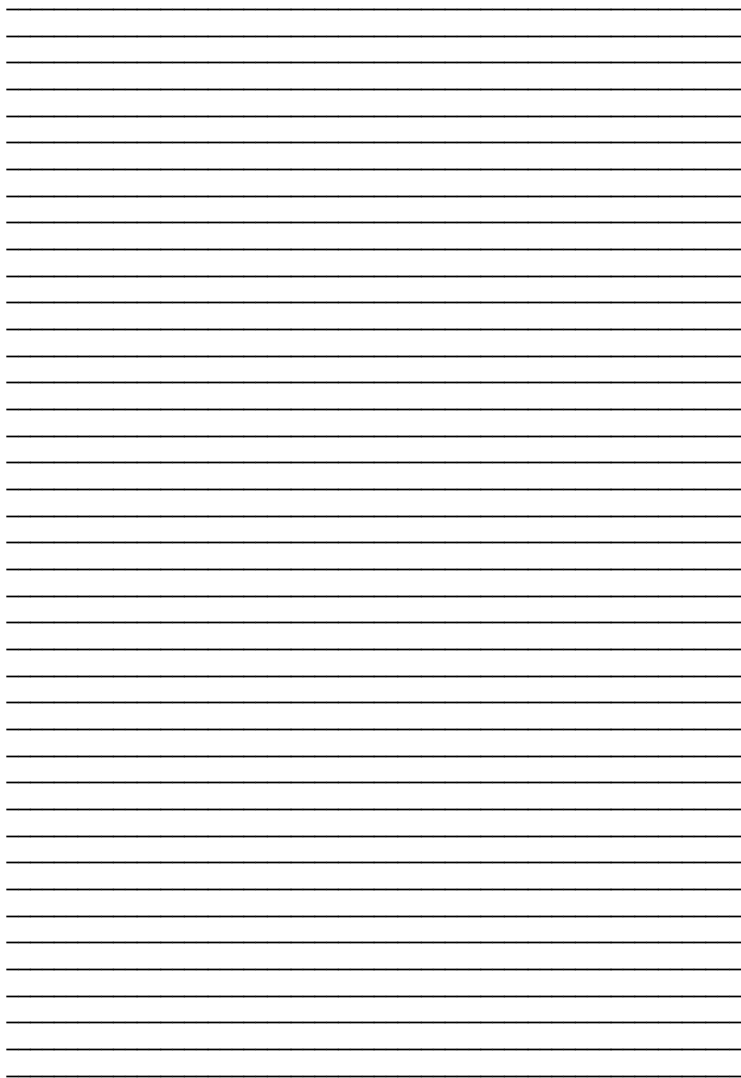

Patents: One or more of the following US patents may apply: 7046142, 6215399, 6111256, 6104319, 5920259, 5886632, 5721542, 5287111, 5119069, 5077549 and RE39406 and other pending patents may apply. Canadian and international patents may also apply.

Trademarks: Imperial, EVO, Spectra SP Series and Esprit are trademarks of Paradox Ltd. or its affiliates in Canada, the United States and/or other countries.

Certification: For the latest information on products approvals, such as UL and CE, please visit www.paradox.com.

Warranty: For complete warranty information on this product please refer to the Limited Warranty Statement found on the website www.paradox.com/terms. Your use of the Paradox product signifies your acceptance of all warranty terms and conditions.

© 2013 Paradox Ltd. All rights reserved. Specifications may change without prior notice.

For technical support in Canada or the U.S., call 1-800-791-1919,
Monday to Friday from 8:00 a.m. to 8:00 p.m. EST. For technical
support outside Canada and the U.S., call 00-1-450-491-7444,
Monday to Friday from 8:00 a.m. to 8:00 p.m. EST.
Please feel free to visit our website at www.paradox.com.