

User Manual

Tilt Color video door phone CDV-70KPT











- Thank you for purchasing COMMAX products.
- Please carefully read this User's Guide (in particular, precautions for safety) before using a product and follow instructions to use a product exactly.
- The company is not responsible for any safety accidents caused by abnormal operation of the product.

Table of Contents











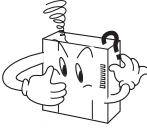

1. Warnings and Cautions.....	2
2. Part Names	3
3. Package Contents	3
4. Wiring and Connection Instructions.....	4
5. Installation.....	4
6. Operation	5
7. Settings	6
8. Specifications and Features.....	7

1. Warnings and caution

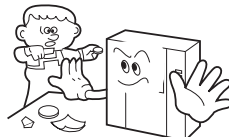
Please follow the things described below in order to prevent any danger or property damage.

 Warning It may cause a serious damage or injury if violated.  Caution It may cause a minor damage or injury if violated.	<ul style="list-style-type: none">  Prohibition.  No disassembly  No touch  Must follow strictly.  Shows plugging out the power cord without an exception  Shows the warning and caution for an electric shock.  Shows the warning and caution for a fire.
---	---

Warning & Caution

Cleaning & Use	<p>Please don't disassemble, repair or rebuild this product arbitrarily (please contact the service center if a repair is needed).</p> <ul style="list-style-type: none"> It may cause an electric shock or fire.      <p>Electric shock Fire Unplug</p>	<p>If an abnormal sound, burning smell or smoke is coming out of the product, please plug out the power cable and contact a service center.</p> <ul style="list-style-type: none"> It may cause an electric shock or fire.    <p>Electric shock Fire</p>	<p>Please don't insert any metallic or burnable materials into the ventilation hole.</p> <ul style="list-style-type: none"> It may cause an electric shock or fire.     <p>Prohibition Electric shock Fire</p>	<p>When cleaning the product, please rub it with a soft and dry cloth after plugging out the power cable. (Please don't use any chemical products such as wax, benzene, alcohol or cleanser.)</p>   <p>Prohibition</p>
---------------------------	--	---	---	--

! Warning & Caution

Power & Installation

Please don't use several products at the same time on one power socket.
 · It may cause a fire due to an abnormal overheating.

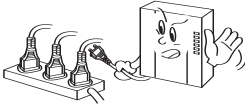

Please don't bend the power cable excessively or it may cause an electric shock.
 · fire when using a damaged power cable.

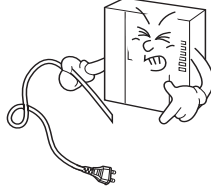

Please don't handle the power cable with a wet hand.
 · It may cause an electric shock.

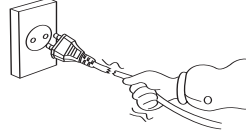

Please plug out the power cable from the socket when not using it for a long period of time.
 · It may shorten the product lifespan or cause a fire.

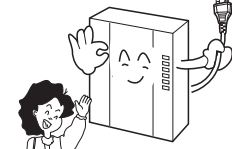

Please don't install the product in the place where there is much oil, smoke or humidity.
 · It may cause an electric shock or fire.

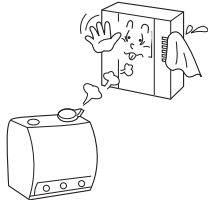

Please don't install the product with the lightning and thunder.
 · It may cause an electric shock or fire.

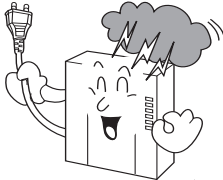

Please don't use and connect this product with other products with different rated voltage.
 · It may cause a disorder or fire.

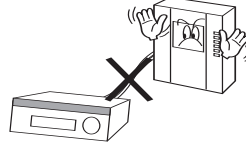

When installing the product that generates heat, please install the product away from the wall (10cm) for the ventilation.
 · It may cause a fire due to the increased internal temperature.

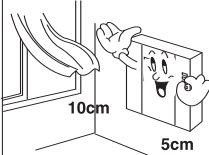

2. Parts Names

Handset Monitor Left Button

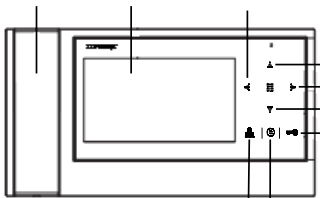

Up Button
 Right Button
 Down Button
 Door Release Button



Interphone Button
 Monitor Button

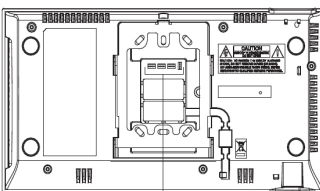

Ringtone
 Volume
 Menu Button
 Select Button
 Up/Down Button
 Power Switch

External Connection Terminal

3. Package Contents



Monitor Fixing
 M3X6 Screw(1EA)

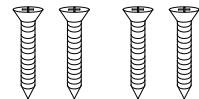

Wall Bracket Mounting
 Screw T4X18(4EA)

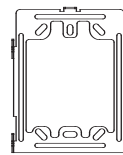

Wall Bracket
 for Monitor(1EA)

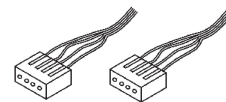

Connector 4P(2EA)

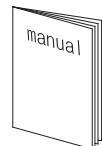

User Manual



4. Wiring and Connection Instructions

▷ Polarity of the camera connector

1. Red: Talk (Audio)
2. Blue: GND
3. Yellow: Power (+12V)
4. White: Video

▷ Polarity of interphone connector

1. Red: Talk (Audio)
2. Blue: GND
3. Yellow: Power (+14V)
4. White: Call signal

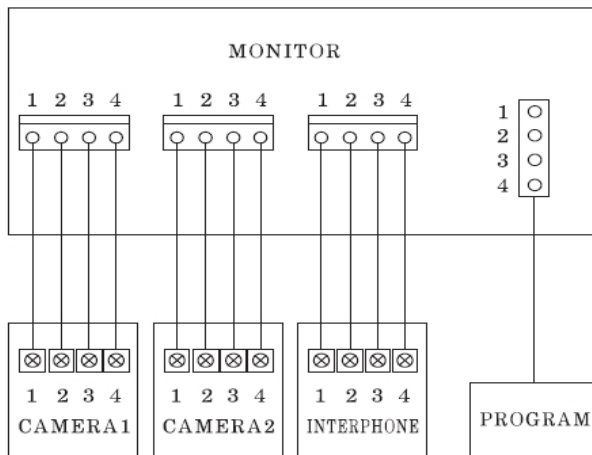

- * Each device should be connected by separated cables.
If you use UTP CABLE[CAT.5] for CAMERA1 and CAMERA2, 2 lines of UTP cable are required.



5. Installation

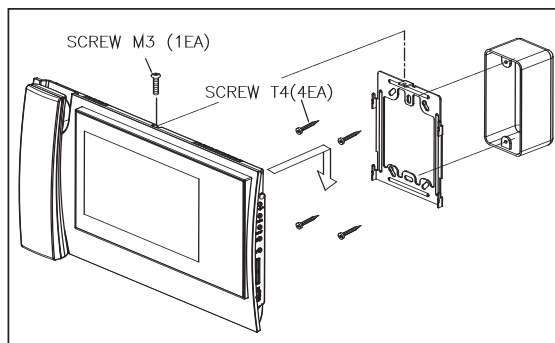

! Note

- ① Avoid the range of direct sunlight
- ② Recommended height is pertinent from 1450 ~ 1500mm
- ③ Avoid the installation near magnetic activity, humid temperatures and gas

DOOR CAMERA & INTERPHONE Wiring

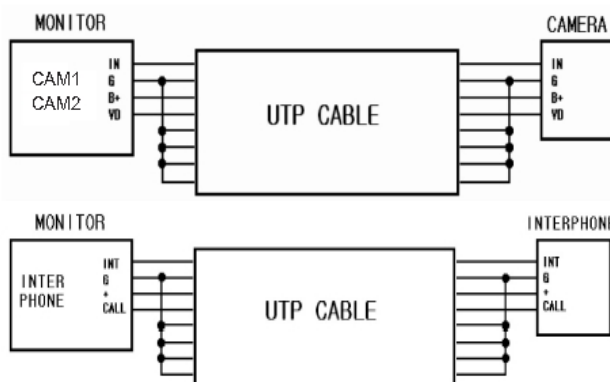

- * If you use UTP CABLE[CAT.5], connect the rest 4 lines to GND after connecting 4 lines between monitor and interphone.

6. Operation

※ **Caution** : Do not hold the handset at your ear when you press hook switch to switch call.

1. Calling of visitor

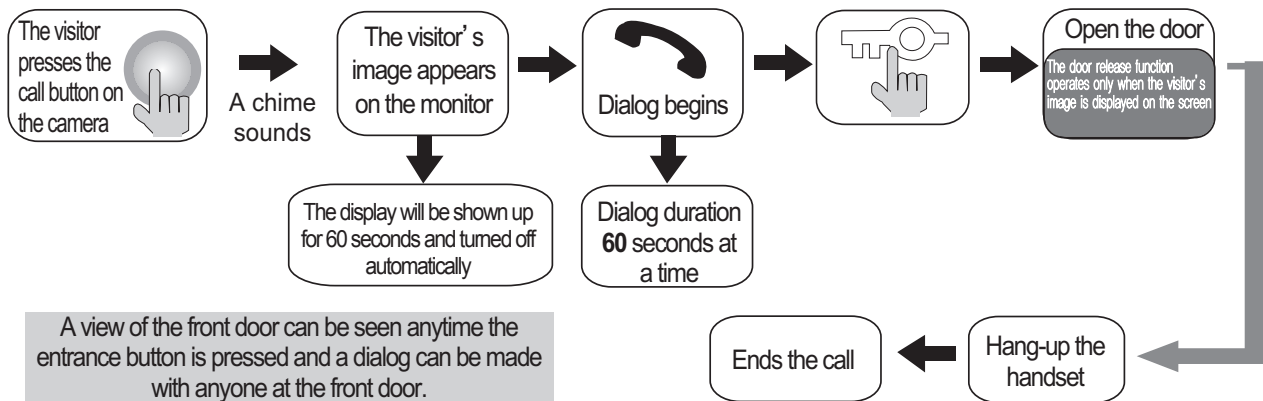

2. Communication with the optional Interphone



Dialog between the interphone and camera is possible only when the visitor's image is visible on the monitor screen.

3. Monitoring : function to see the image of visitor in the entrance.

(On stand-by mode - status of putting handset down) Operation

- By pressing the Monitor button repeatedly, the monitor will work as following in order.
Camera 1 → Camera 2 → OFF → Camera 1 →

(One talking mode - status of putting handset up) Operation

- By pressing the Monitor button repeatedly, the monitor will work as following in order.
Camera 1 → Camera 2 → Camera 1 → Camera 2 →

4. Adjust the volume

※ **Caution**

When the call volume control switch is clicked for call volume adjustment, call sound will be heard from the handset 1 time for a user to check the sound.

Please make sure that handset is in position, when the call volume function is being used.

- When call volume control switch is clicked, it will operate in order as follows.
- (Stand by mode - In position)
- CHIME-VOL0 → CHIME-VOL1 → CHIME-VOL2 → CHIME-VOL3 → CHIME-VOL0

5. CAMERA TILT FUNCTION

Users can adjust the image focus to see the place that they want.
Functions are only available with pan tilt cameras.

Display setting "ZOOM, 4:3, 16:9" SCREEN MODE is not available when it is connected to pan tilt cameras.

(Click the front key buttons to use pan tilt function during the monitoring or talk.)

- * Move left : LEFT BUTTON * Move down : DOWN BUTTON
- * Move up : UP BUTTON * Move right : RIGHT BUTTON

- Enlarge or reduce screen size by using UP/DOWN buttons on the side during the monitoring or talk.

UP : Enlarge screen size gradationally (ZOOM - IN)

DOWN : Reduce screen size gradationally (ZOOM - OUT)

* Caution

When the unit is restarted, the zoom mode will be initialized.

7. Settings

- Products settings need the following 4 buttons on the right of product.
- * Move left : LEFT BUTTON * Move down : DOWN BUTTON
- * Move up : UP BUTTON * Move right : RIGHT BUTTON

1. Screen setting (Brightness/Contrast/Color adjustment function)

Press the Menu button and access to DOOR VIDEO SET and enter the setting menu by pressing SELECT button.

(1) BRIGHTNESS : Adjusting Brightness of Screen

(2) CONTRAST : Adjusting Contrast of Screen

(3) COLOR : Adjusting Color of Screen

※ How to adjust

① Move to Menu you want to adjust with navigation button on the list of DOOR VIDEO SET

② Press SELECT button to choose an icon.

③ Adjust the set value with navigation button

④ To complete the set, press SELECT button.

(4) RESET : Initializing

※ How to reset.

① Move to RESET menu in DOOR VIDEO SET menu ② Press SELECT to enter the menu.

③ Select YES with navigation button

④ Press SELECT button.

(5) EXIT : Go back to setting mode

2. UTILITY(additional function)

Press the Menu button and access to Utility SET and enter the menu by pressing SELECT button.

(1) CHIME-BELL VOLUME : setting volume sound .

- ① Move to CHIME-BELL VOLUME icon with navigation button in UTILITY Menu.
- ② Press SELECT to enter the menu.
- ③ Select the volume sound or not with navigation button.
- ④ To complete the set, press SELECT button.

(2) EXIT : Go back to Setting menu

3. INFORMATION (The function to check Model name & Version)

In order to check the product information, press menu button and move to INFORMATION menu with navigation button.

(1) MODEL : You can check the model name.

(2) VERSION : You can check the model version.

(3) VIDEO : You can check the video transmission formats(NTSC / PAL)

(4) SOURCE : You can check the position of camera(DOOR1 / DOOR2) which is shown on the screen for now.

4. EXIT(Finish setting menu)

5. RESET : Initializing

Keep pushing interphone and door open button for 3 seconds(Screen setting and Call volume will be initialized)

Caution

If initialization is activated, all data including screen setting will be initialized) (Screen setting and Call volume)



8. Specifications and Features

Wiring	4 wires with door camera(Polarity) 4 wires with interphone(Polarity)
Rating Voltage	100-240V~, 50/60Hz (FREE VOLTAGE)
Power consumption	Stand-by : 4.5W Maximum : 16W
Transmission way	HAND SET
Screen	17.78Cm(7") TFT-DIGITAL LCD
Ringtone	Entrance : electronic chime Interphone : electronic buzzer
Screen Display	Monitoring : 30 ±5sec , Talk : 60 ±5sec
Distance from Camera	28m(Φ0.5) / 50m(Φ0.65) / 70m(Φ0.8)
Working temperature	0 ~+40°C (32°F ~ 104°F)
Dimension	311(W) X 168(H) X 32(50.3)(D)

COMMAX