

# User Manual

Color Video Door Phone CMV-43A



- Thank you for purchasing COMMAX products.
- Please carefully read this User's Guide (in particular, precautions for safety) before using a product and follow instructions to use a product exactly.
- The company is not responsible for any safety accidents caused by abnormal operation of the product.



# Table of Contents

1. Greetings .....	1
2. Warnings and Cautions.....	2
3. Part Names and Functions .....	4
4. Operation .....	5
5. Settings .....	10
6. Installation .....	12
7. Wiring and Connection Instructions. ....	14
8. Extension of monitors .....	15
9. Package Contents .....	16
10. Specifications and Features.....	17
11. Safe Operation guide .....	17



## 1. Greetings

- Thank you for Purchasing COMMAX Products
- Please carefully read this User's Manual (in particular, precautions for safety) before using a product and follow instructions to use a product exactly.



## 2. Warnings and cautions

Please follow the things described below in order to prevent any danger or property damage.

	<b>Warning</b>	It may cause a serious damage or injury if violated.
	<b>Caution</b>	It may cause a minor damage or injury if violated.

	Prohibition.
	No disassembly
	No touch
	Must follow strictly.
	Shows plugging out the power cord without an exception
	Shows the warning and caution for an electric shock.
	Shows the warning and caution for a fire.

### Warning

#### Power & Installation

Please don't use several products at the same time on one power socket.

- It may cause a fire due to an abnormal overheating.

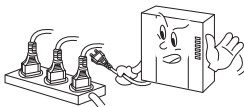

Please don't bend the power cable excessively or it may cause an electric shock.

- fire when using a damaged power cable.

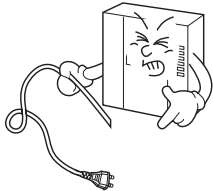

Please don't handle the power cable with a wet hand.

- It may cause an electric shock.

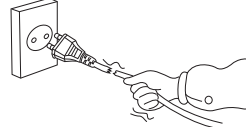

Please plug out the power cable from the socket when not using it for a long period of time.

- It may shorten the product lifespan or cause a fire.

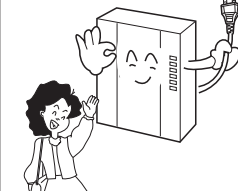

Please don't install the product in the place where there is much oil, smoke or humidity.

- It may cause an electric shock or fire.

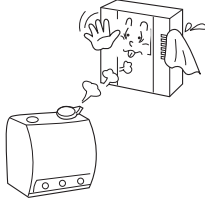

Please don't install the product with the lightning and thunder.

- It may cause an electric shock or fire.

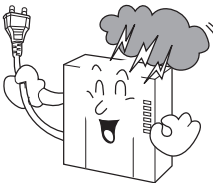

Please don't use and connect this product with other products with different rated voltage.

- It may cause a disorder or fire.

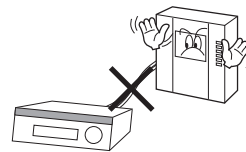

When installing the product that generates heat, please install the product away from the wall (10cm) for the ventilation.

- It may cause a fire due to the increased internal temperature.

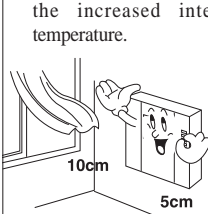

## ! Warning

### Cleaning & Use

Please don't disassemble, repair or rebuild this product arbitrarily (please contact the service center if a repair is needed).

- It may cause an electric shock or fire.

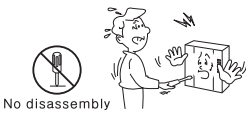

If an abnormal sound, burning smell or smoke is coming out of the product, please plug out the power cable and contact a service center.

- It may cause an electric shock or fire.

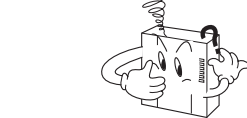

Please don't insert any metallic or burnable materials into the ventilation hole.

- It may cause an electric shock or fire.

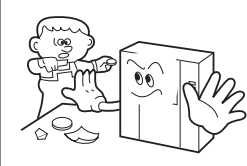

Please use only the designated batteries for the products of using DC power.

- It may cause an electric shock or fire.

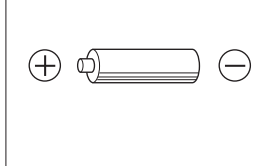

## ! Caution

### Power & Installation

Please plug the power cable firmly into the inner end

- It may cause a fire.

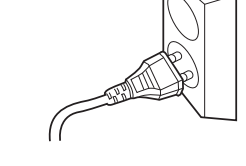

Please hold the plug tightly when unplugging the power cable (a part of the copper wire may be disconnected if the grabbing is only made on the cord when pulling out the cable).

- It may cause an electric shock or fire



When connecting the power cables after cutting the cable, please install the product with power off

- It may cause an electric shock or fire

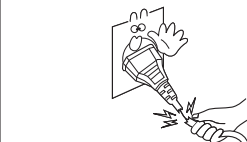

When installing the product, please fix it firmly while using the wall-mounting unit and screws.

- It may cause an injury from the falling object.

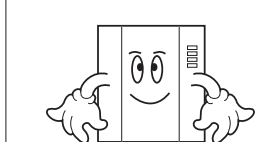

Please be careful when using an AC circuit breaker since there is a possibility of an electric shock.

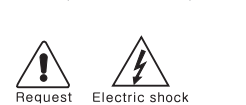
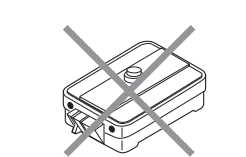

Please check the use voltage and current for the DC-only products and use the appropriate rectifier.

- It may cause a fire.



Please avoid direct rays of the sun or heating devices at a time of installation.

- It may cause a fire.

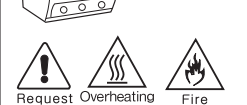
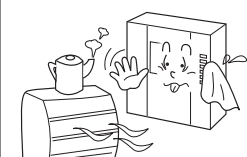

Please don't install the product on an unstable place or small support board.

- It may cause an injury if it falls down while in use.

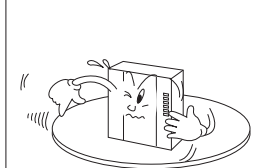

### Cleaning & Use

When cleaning the product, please rub it with a soft and dry cloth after plugging out the power cable. (Please don't use any chemical products such as wax, benzene, alcohol or cleanser.)



Please don't drop the product on the ground and don't apply a shock.

- It may cause a failure.

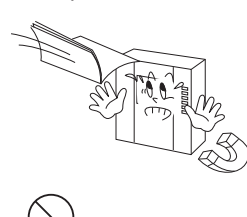

Please use the designated connection cable within the maximum calling distance designated for the product

- It may reduce the product performance.

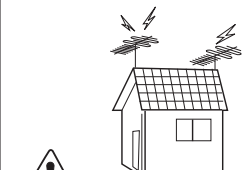



### 3. Parts Names and Functions

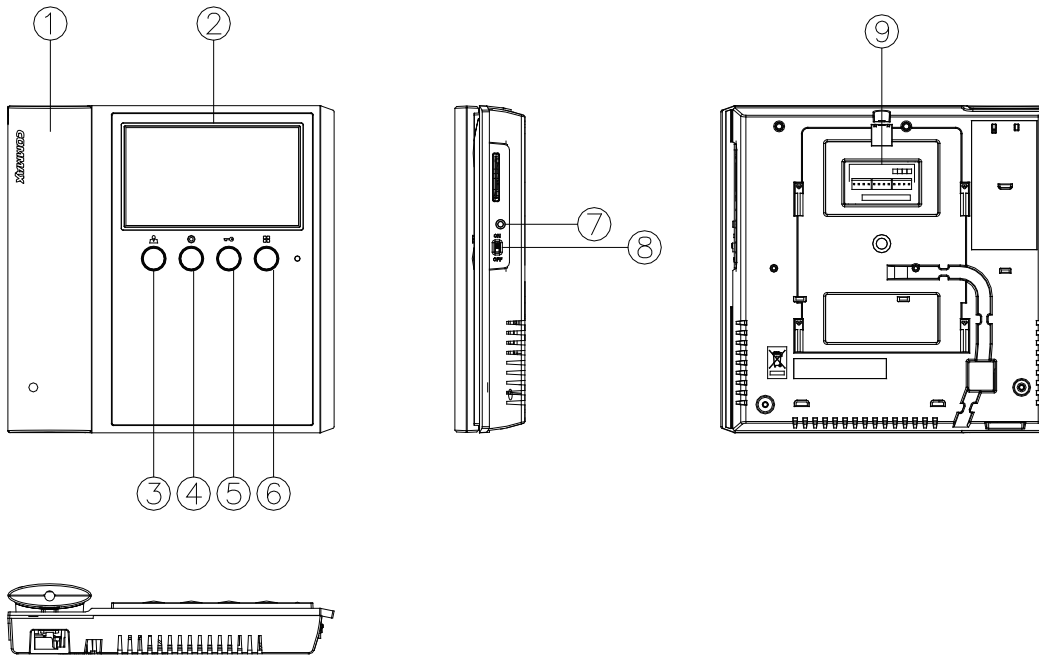

No.	Part Name	Description
1	Handset	Hand set receiver
2	TFT-LCD	Display visitor's image
3	Monitoring button	Screen view of door cameras
4	Interphone button	Call an interphone
5	Door open button	Open the door
6	Menu button	Display setting menu
7	Call volume Controller	Control the call sound level
8	Power switch	ON/OFF switch
9	Terminal for Exterior	Terminal for product upgrade, entrance camera and interphone

# 4. Operation

※ **Caution** : Do not hold the handset at your ear when you press hook switch to switch call.

## 1. Calling of visitor

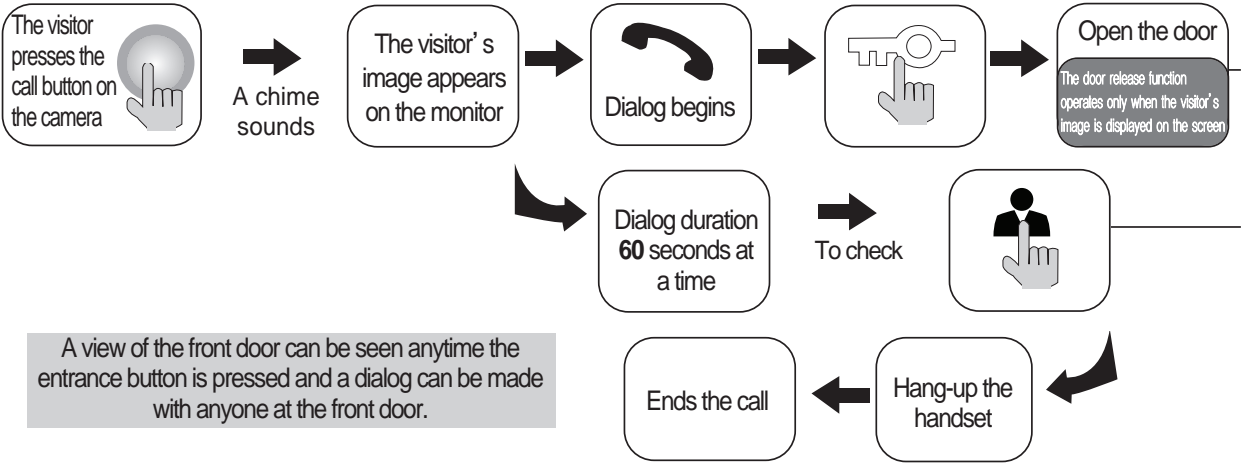

\* In case of connecting two cameras

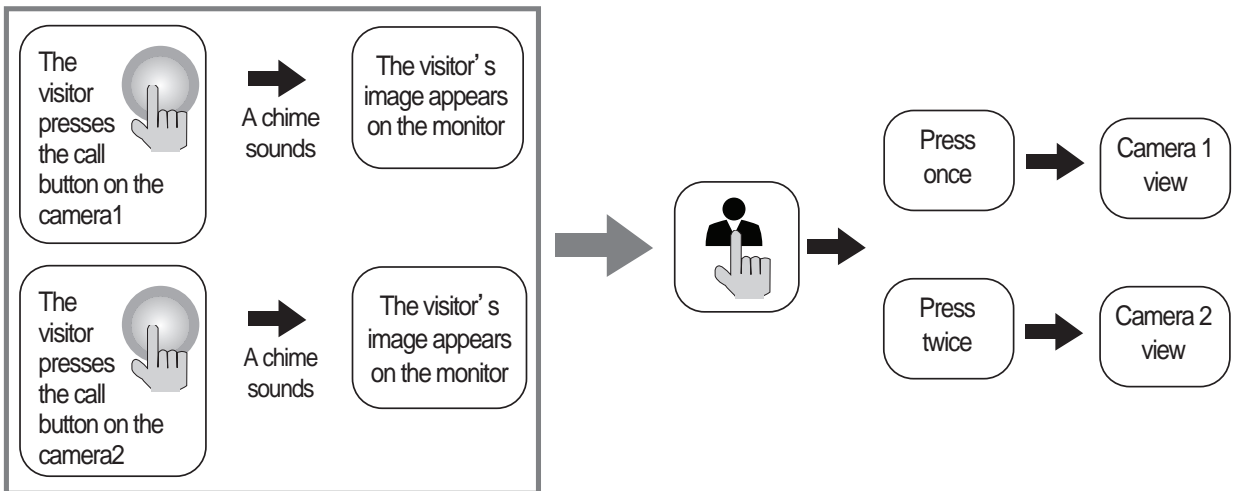

## 2. Communication with the optional Interphone

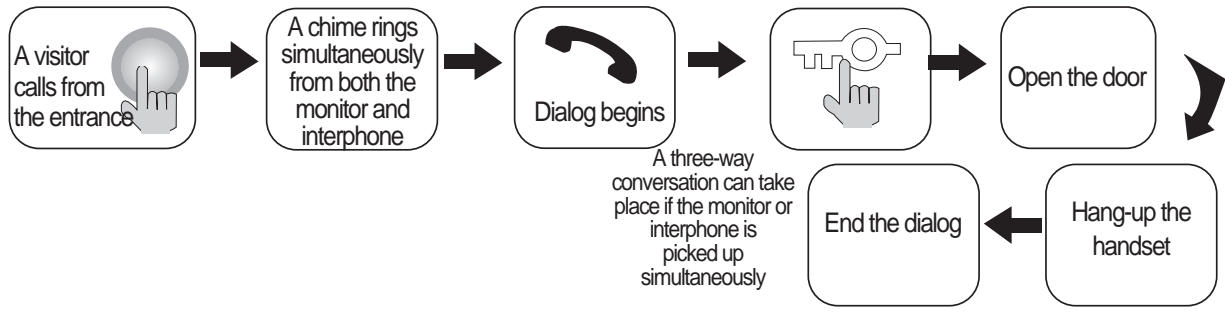

Dialog between the interphone and camera is possible only when the visitor's image is visible on the monitor screen.

### 3. Monitoring : function to see the image of visitor in the entrance.

(stand-by mode) Operation

- By pressing the Monitor button repeatedly, the monitor will work as following in order.

Camera 1 → ( Camera 2 ) → OFF → Camera 1 .....

(On talking mode)Operation

- By pressing Monitor button repeatedly, the monitor will work as following in order.

Camera1 → ( Camera 2 ) → Camera 1 → ( Camera 2 ) .....



### 4. Connect with lobby / guard station / CCTV (Only for MODUM system)

\* The picture as below will be displayed automatically when you use it as MODUM system. If there is no connection with floor distributor(CCU-404FU), this picture will not be displayed. (For the recognition for MODUM system, please re-boot the device when you finished the installation.)

1 ) Paging and talking with the guard station :

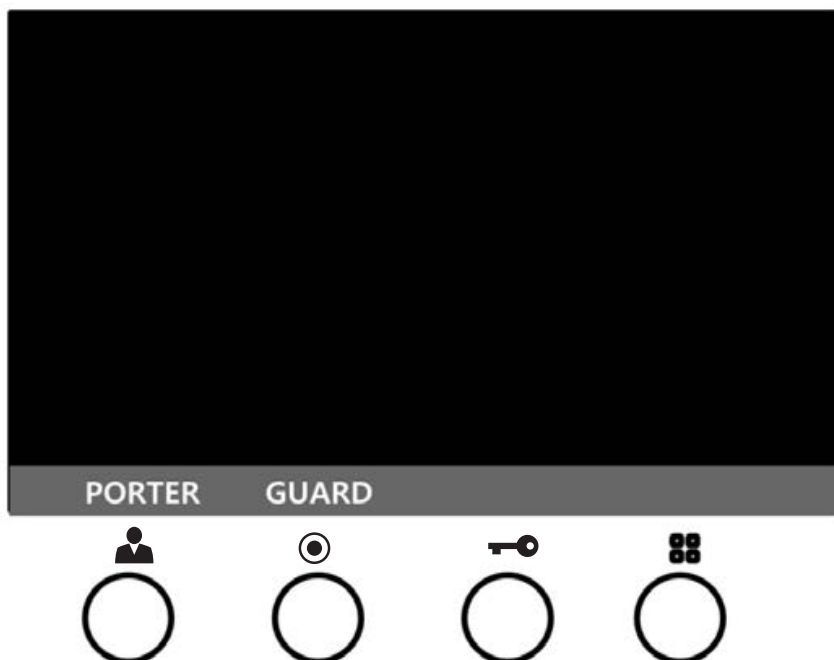
When you lift the handset and push the interphone paging button, you can see the 'PORTER' and 'GUARD' at the bottom of display.





- For the paging the 'PORTER', to push the  button while the menu is displayed.
- : You can talk with porter when he answers the call.
- For the paging the 'GUARD', to push the  button while the menu is displayed.
- : You can talk with guard when he answers the call.

2) For monitoring (Individual door camera / lobby / CCTV ) :

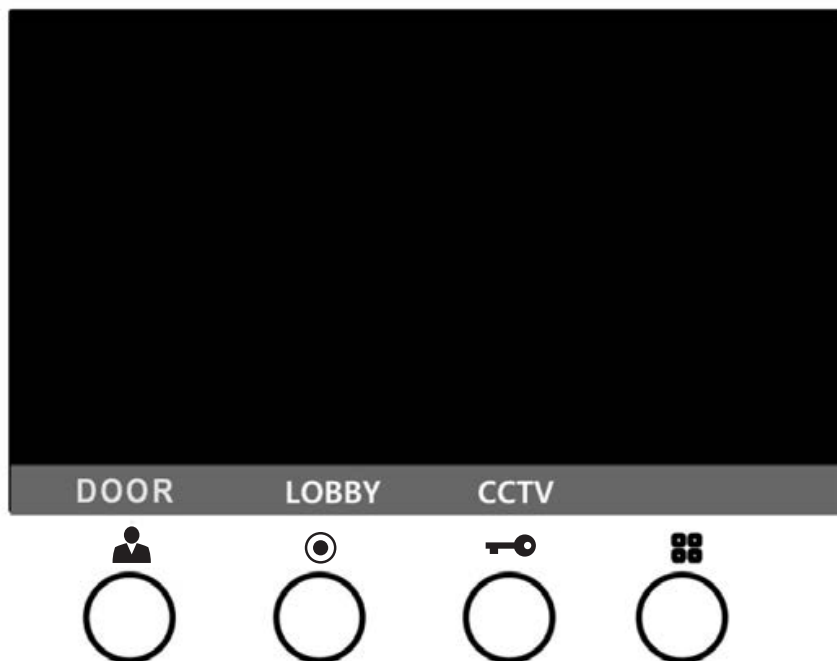
If you push the monitoring button on the standby mode, you can see the 'DOOR', 'LOBBY' and 'CCTV' at the bottom of display.



- For the monitoring individual door camera, push the  button while the menu is displayed.
- : During monitoring, if you lift the handset, you can talk with outside.
- For the lobby monitoring, push the  button while the menu is displayed.
- : During monitoring, if you lift the handset, you can talk with lobby.
- For the CCTV monitoring, push the  button while the menu is displayed.
- : If you select the CCTV monitoring function, there will be additional selection window. If you lift the handset, it will be terminated. (To refer the manual as below for CCTV monitoring)



3) Menu to choose CCTV Monitoring( Private entrance, public entrance / CCTV)

1,2,3, ► will be shown at the below of the screen if you press the Monitoring button for CCTV.

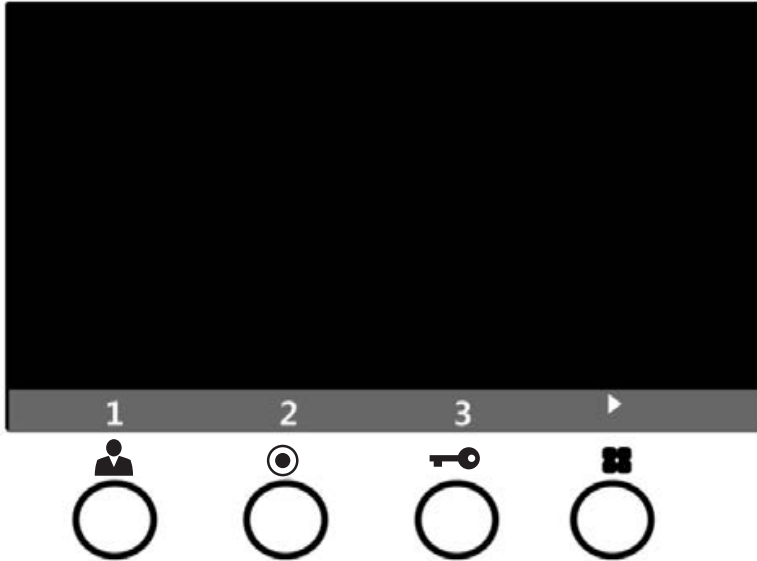

- 1 Press the button related to the CCTV which you want to monitor among 1~3.(the CCTV screen will be shown up )

- If you want to monitor another CCTV,Press the button ► & go to next screen.

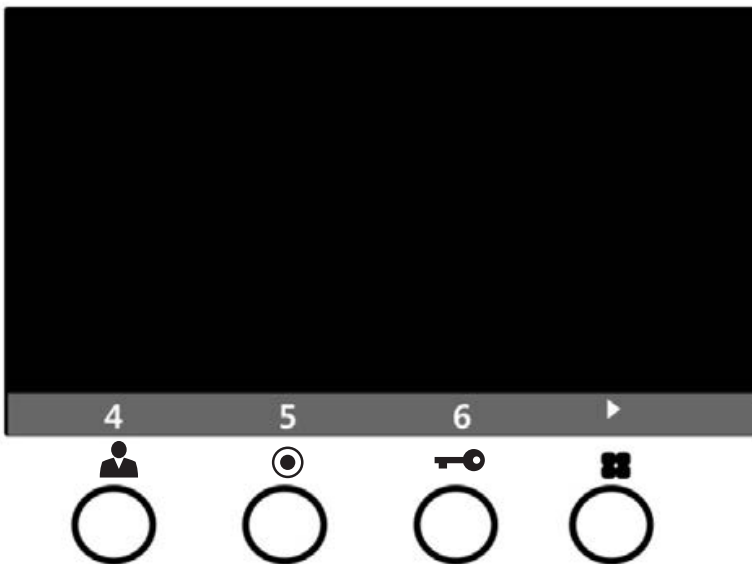

- Press the button related to the CCTV which you want to monitor among 4~6. (the CCTV screen will be shown up )
- If you want to monitor another CCTV, Press the button ► go to next screen.

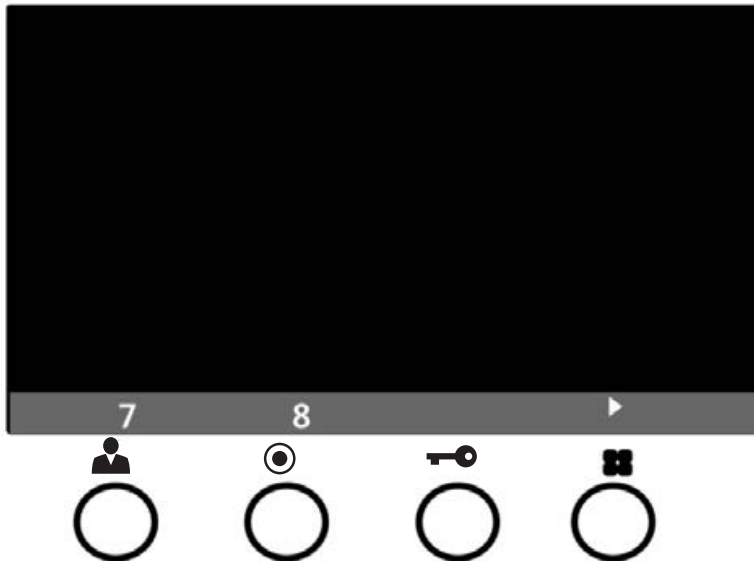

- Press the button related to the CCTV which you want to monitor between 7,8.(the CCTV screen will be shown up )
- if you press the button ► , it will go to the initial selection screen,.

\*\*\*REFERENCE\*\*\*

1. The function will be closed down if you pick up the handset on the menu selection CCTV Monitoring.
2. press the another selection button if you want to monitor another CCTV while monitoring the CCTV.  
(but, it will go back to standby status after closing the monitoring if you press twice the button chosen among the same monitoring. )
3. CCTV can be chosen up to 8. and The possible quantity will be marked automatically.



## 5. Settings

- You can adjust DOOR VIDEO SET, UTILITY and check INFORMATION(model name & version) with (UP)△ / (DOWN)▽ button after pressing Menu button on the front of the product in video talk mode or stand-by monitoring.

- **Products settings need the following 4 buttons on the right of product.**

- \* Start Menu / Exit : MENU button
- \* Select and in-put : SELECT (Interphone button)
- \* Move up / Move right : △ / ▷ (Open button)
- \* Move down / Move left : ▽ / ◁ (Monitoring button)

### 4-1. Screen setting (Brightness/Contrast/Color adjustment function)

Press the Menu button and access to DOOR VIDEO SET and enter the setting menu by pressing SELECT button.

- (1) BRIGHTNESS : Adjusting Brightness of Screen
- (2) CONTRAST : Adjusting Contrast of Screen
- (3) COLOR : Adjusting Color of Screen

※ How to adjust

- ① Move to Menu you want to adjust with △/▽ button on the list of DOOR VIDEO SET
- ② Press SELECT button to choose an icon.
- ③ Adjust the set value with ◁/▷ button
- ④ To complete the set, press SELECT button.

- (4) RESET : Initializing

※ How to Reset

- ① Move to RESET menu in DOOR VIDEO SET menu
- ② Press SELECT to enter the menu.
- ③ Select YES with ◁/▷ button
- ④ Press SELECT button.

- (5) EXIT : Go back to setting mode

### 4-2. UTILITY (additional function)

Press the Menu button and access to Utility SET and enter the menu by pressing SELECT button.

- (1) CHIME-BELL VOLUME : setting call sound level

- ① Move to CHIME-BELL VOLUME icon with △ /▽ button in UTILITY Menu.
- ② Press SELECT to enter the menu.

- ③ Adjusting call level : 0(MUTE) ~ 3(MAX)
- ④ To complete the set, press SELECT button.

(2) SCREEN MODE : to set for screen ratio

- ① ZOOM: Zoon in(expansion) image maintaining actual ratio(4:3) is shown. (full of the screen)
- ② 4:3: Image of 4:3 ratio without expansion is shown.(This is actual ratio for camera)
- ③ WIDE: Full of the screen. Not actual ratio (4:3). Image is expanded according to LCD (WIDE LCD) ratio.

※ How to adjust

- ① Access to SCREEN MODE with  $\Delta$  /  $\nabla$  button in UTILITY Menu
- ② Press SELECT button to enter the menu.
- ③ Adjust screen ratio value with  $\leftarrow$  /  $\rightarrow$  button.
- ④ To complete the set, press SELECT button.

(3) EXIT : Go back to Setting menu

4-3. INFORMATION (The function to check Model name & Version)

In order to check the product information, press menu button and move to INFORMATION menu with  $\leftarrow$  /  $\rightarrow$  button.

- (1) Model : You can check the model name.
- (2) Version : You can check the model version.
- (3) VIDEO : You can check the video transmission formats(NTSC / PAL)
- (4) SOURCE : You can check the position of camera(DOOR1 / DOOR2) which is shown on the screen for now.
- 5) HOME ID : You can check the Building/household number.  
(when you use it as MODUM system, you can see the 'HOME ID')

4-4. EXIT(Finish setting menu)



## 6. Installation

### ▷ Monitor installation

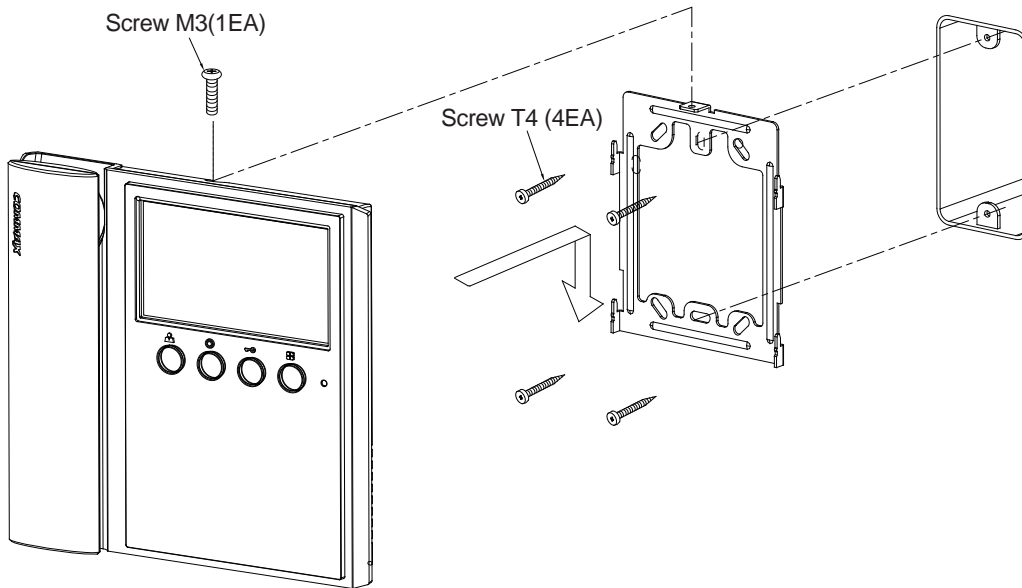

#### \* Note

- Avoid installing the product in the area of direct sunlight.
- The position of the unit's body should fit the standard height range (Recommended height range is 1450 ~ 1500mm.)
- Avoid installing the product exposed to gas exposure, magnetic force, in humid temperatures, as it may damage the condition and performance of the product.

▷ Camera Installation (at DRC-4MC)

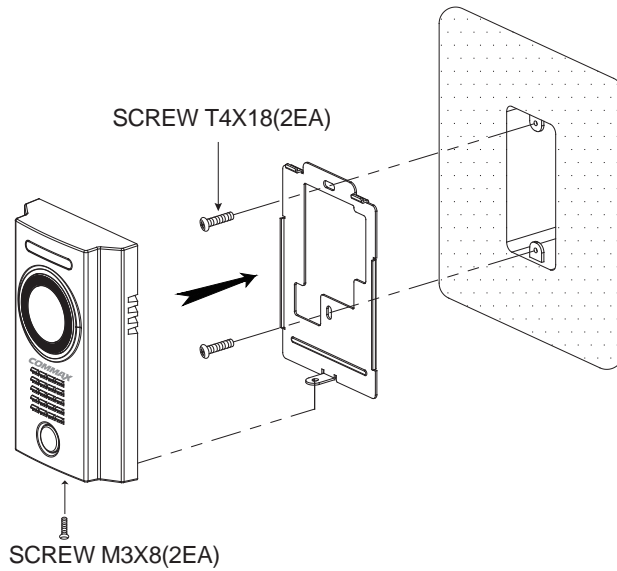

**\* Note**

- Do not install a door camera in the area exposed to direct sunlight or backlight.
- Please keep the lens clean for the clearest image reflection.



# 7. Wiring and Connection Instructions.

## ▷ Polarity of the camera connector

1. Red: Talk (Audio)
2. Blue: GND
3. Yellow: Power (+12V)
4. White: Video

## ▷ Polarity of interphone connector

1. Red: Talk (Audio)
2. Blue: GND
3. Yellow: Power (+14V)
4. White: Call signal

CMV-43A

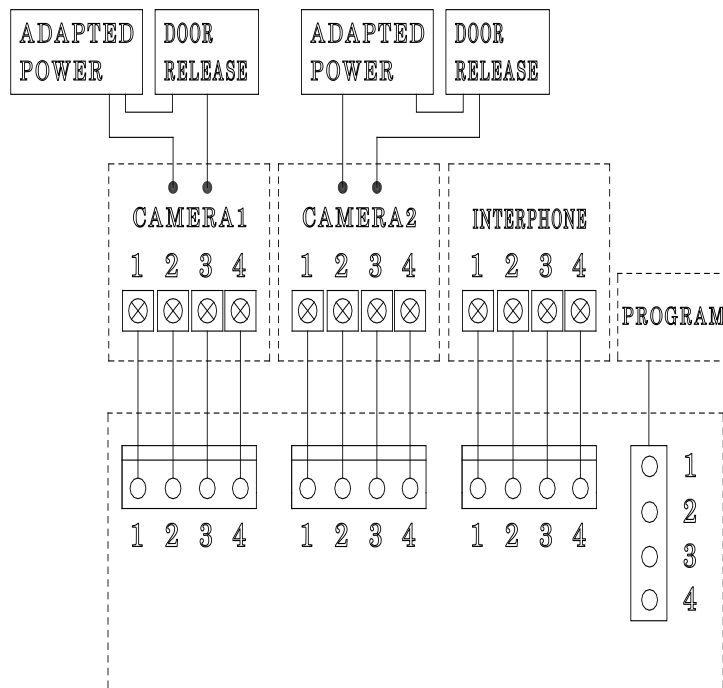

\* If you connect with MODUM system, you need to connect with 'CAMERA2' ports and floor distributor(Please refer to the manual of floor distributor for wiring.)

### Warning :

- If you connect with a floor distributor(to connect with lobby or guard station), you have to connect with only 'CAMERA2' port.(If you connect with 'CAMERA1' port and floor distributor, it will not be operated normally.)
- Do not use it with other devices when you use it with floor distributor, other devices,
- When the system power cut off in case of blackout, each device can't be recognized to each other because of communication problem. In this case, re-boot the Video-phone.

**\* Note**

1. In case, if there is a high-voltage power line in the area of installation, use metal tube coaxial cable for wiring
2. Beware of wrinkling of line coating and cable stick-outs as it may cause circuit shortage and operation inconvenience.
3. When connecting a monitor with a camera, make sure power switch is turned off.

## 8. Extension of monitors

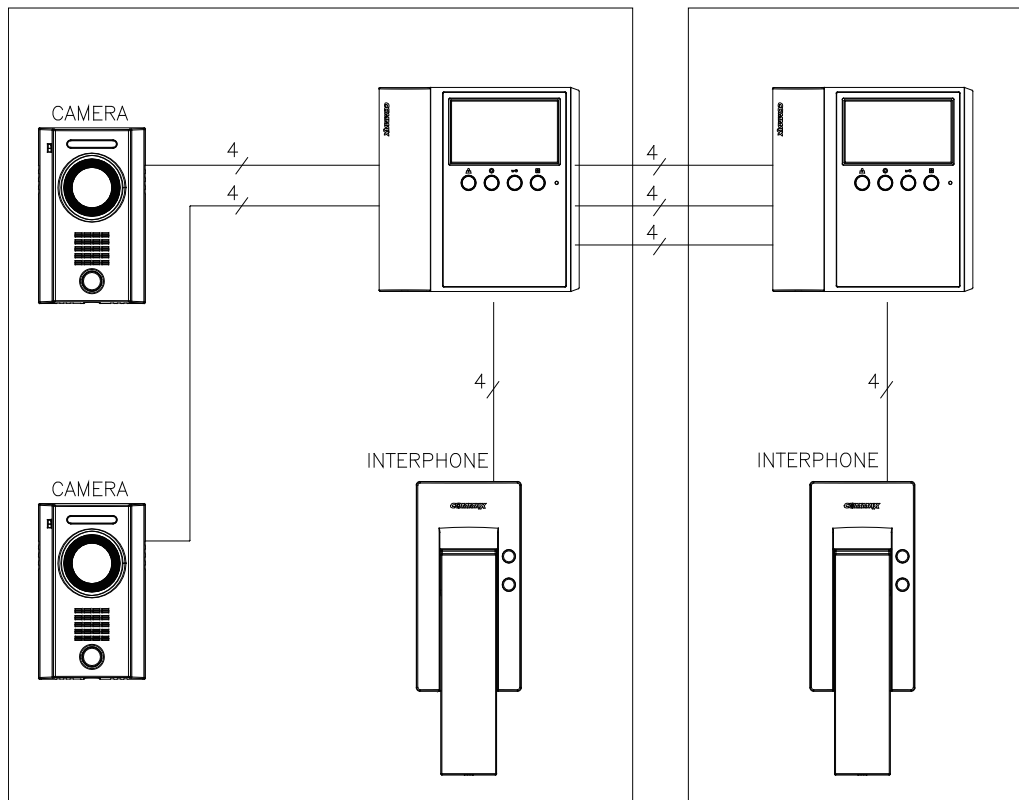

\* Extendable

\* When adding a second monitor, visual and audio quality of video may deteriorate



# 9. Package Contents

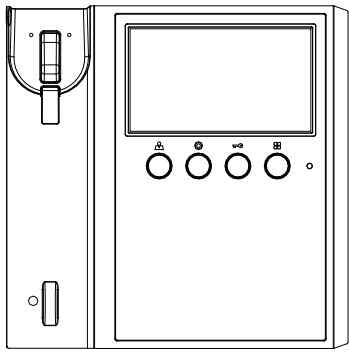

①

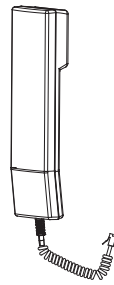

②

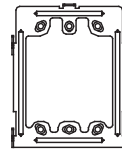

③



④

Screw for body  
SCREW M3 X 6 (1EA)

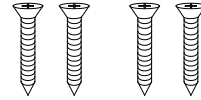

⑤

Screw for wall mount  
SCREW T4 X 18 (4EA)

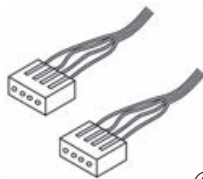

⑥

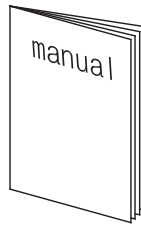

⑦

① Monitor(CMV-43A )	.....	1EA
② Handset	.....	1EA
③ Wall bracket for monitor	.....	1EA
④ Monitor fixing screw	.....	1EA
⑤ Wall bracket mounting screw	.....	4EA
⑥ Connector (4P)	.....	2EA
⑦ User Manual	.....	1EA



## 10. Specifications and Features

### CMV-43A

Rated Voltage	100-240V~, 50/60Hz
Power Consumption	Operating : 10W
Wiring	4 wires with door camera (Polarity), 4 wires with an Interphone (Polarity)
Screen Size	Color 4.3" TFT LCD
Communication	Simultaneous communication
Call Sound	From a door camera : Electric chime From an interphone : Beep sound
Time to display the screen	60 ± 10sec
Distance from camera	28m(Φ0.5) / 50m(Φ0.65) / 70m(Φ0.8)
Operating Temperature	0 ~ +40°C (32° F ~ 104° F)

Reference : Design and functions of the product are a subject of constant development as a pursuit of quality improvement



## 11. Safe Operation guide

- Make sure to turn on the product
- In case if physical damage or operation failure is detected, do not hesitate to contact Service Center
- All electric power must be blocked by the building blocking device
- Do not place water bottles or flowerpots upon the product
- Please, turn the power off when installing or repairing the product

***COMMAX***