

## GV-EBD8813 AI 8MP H.265 4.3x Zoom Super Low Lux WDR Pro IR Eyeball IP Dome



- AI Deep learning: AI Perimeter Protection & Classification (Human, Vehicle)
- 1/2.8" progressive scan super low lux CMOS sensor
- Triple streams from H.265, H.264 or MJPEG
- Wide Dynamic Range Pro (WDR Pro)
- Min. illumination at 0.003 lux
- Up to 20 fps at 3840 x 2160
- Intelligent IR
- Day and night function (with removable IR-cut filter)
- Motorized varifocal lens for remote focus / zoom adjustment
- 3-axis mechanism (pan / tilt / rotate)
- IR distance up to 40 m (130 ft)
- Vandal resistance (IK10 for metal casing)
- Ingress protection (IP67)
- Built-in micro SD card slot (SD / SDHC / SDXC / UHS-I) for local storage
- Built-in microphone
- DC 12V / PoE (IEEE 802.3af)
- ONVIF (Profile G, S, T) conformant

### Introduction

The Eyeball Dome IP Camera is an outdoor, network camera equipped with an automatic IR-cut filter and IR LEDs for day and night surveillance. The camera supports H.265 video codec to achieve better compression ratio while maintaining high quality pictures at reduced network bandwidths. GV-EBD8813 adheres to IK10 and IP67 standards, and can be powered through PoE.

Empowered by deep learning algorithms, AI technology distinguishes human and vehicles from other moving objects. Integrated with GeoVision Video Management Software (VMS), it supports AI perimeter protection, real time alert, events playback and more.

### Deep Learning Function

#### AI Perimeter Protection

(Intrusion, Crossing Line  
Entering Area, Leaving Area)

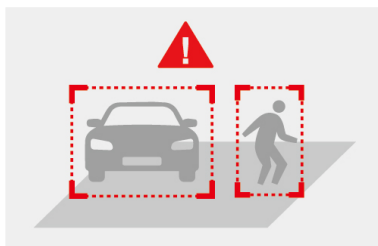

#### AI Event Search

(VMS V18.3 or later)



**Note:** The integration of AI events of the camera to GV-VMS is coming soon.

## Dimensions

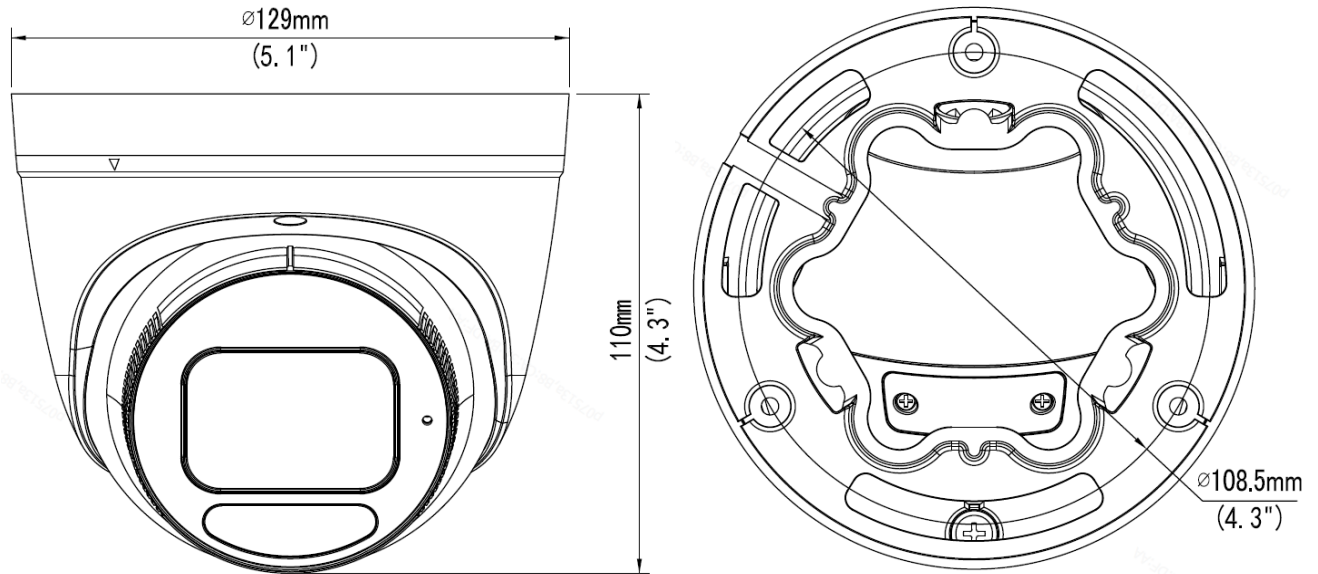

## Specifications

### Camera

Image Sensor	1/2.8" progressive scan super low lux CMOS	
Picture Elements	3840 (H) x 2160 (V)	
Minimum Illumination	Color	0.003 Lux (F1.5, AGC ON)
	IR ON	0 Lux
Shutter Speed	Auto / Manual (1 ~ 1/100000 sec)	
White Balance	Auto / Manual	
Gain Control	Auto / Manual	
S/N Ratio	56 dB	
WDR	WDR Pro	
Dynamic Range	120 dB	

### Lens

Megapixel	8 MP	
Day / Night	Yes (with removable IR-cut filter)	
Lens Type	Motorized varifocal lens	
Focal Length	2.8 ~ 12 mm	
Maximum Aperture	F/1.6	
Mount	$\varnothing 12\text{ mm}$	
Horizontal FOV	107° ~ 29°	
Operation	Focus	Auto / Manual
	Zoom	4.3x Optical Zoom
	Iris	Fixed
IR LED Quantity	2 IR LEDs	
Max. IR Distance	40 m (130 ft)	

### Operation

Video Compression	H.265, H.264, MJPEG	
Video Streaming	Triple streams	
Frame Rate	20 fps at 3840 x 2160, 25 fps at 3072 x 1728 / 2560 x 1440, 30 fps at 1920 x 1080 (60 / 50 Hz)	
	*The frame rate and performance may vary depending on the number of connections and data bitrates (different scenes).	
Video Analytics	Motion Detection, Tampering Alarm, Audio Detection *Tampering alarm and audio detection are only accessible through the camera's Web interface, which can be used to trigger alerts such as e-mail and FTP.	
Image Setting	Brightness, Contrast, Saturation, Sharpness, Flicker-less, Image Orientation (Flip, Mirror, 0°, 90°, 180°, 270°-including Corridor format)	
Audio Compression	G.711	
Audio Support	One-way Audio	

Deep Learning Function		
AI Perimeter Protection	Intrusion, Crossing Line, Entering Area, Leaving Area (Human & Vehicle classification)	
Video Resolution		
Main Stream	3840 x 2160 (Default), 2944 x 1656, 2592 x 1944, 2560 x 1440, 1920 x 1080	
Sub Stream	1920 x 1080, 1280 x 720, 720 x 576, 704 x 288, 640 x 360 (Default), 352 x 288	
Third Stream (Closed by Default)	720 x 576, 704 x 288, 640 x 360, 352 x 288	
Network		
Interface	10/100 Ethernet	
Protocol	ARP, DHCP, DDNS, DNS, DynDNS, FTP, HTTP, HTTPS, ICMP, IGMP, IPv4, NTP, PPPoE, RTCP, RTP, RTSP, SMTP, TCP, UDP, UPnP, ONVIF (Profile G, S, T)	
Mechanical		
Camera Angle Adjustment	Pan	0° ~ 360°
	Tilt	0° ~ 75°
	Rotate	0° ~ 360°
Connectors	Power	DC Jack (DC 12V, 1.25A), PoE
	Ethernet	RJ-45
	Audio	1 In (built-in microphone)
	Local Storage	Micro SD card slot (SD/SDHC/SDXC/UHS-I, Class 10) *UHS-II card types are not supported.
General		
Environment Temperature	Start-up	-30°C ~ 60°C (-22°F ~ 140°F)
	Operation	
Humidity	0% ~ 95% (no condensation)	
Power Source	12V DC / PoE (IEEE802.3af)	
Max. Power Consumption	8.16W	
Dimensions	Ø 129 x 110 mm (Ø5.1" x 4.3")	
Weight	0.67 kg (1.48 lb)	
Ingress Protection	IP67	
Vandal Resistance	IK10 for metal casing	
Regulatory	CE, FCC, RoHS compliant	
Web Interface		
Installation Management	Web-based configuration	
Maintenance	Firmware upgrade through Web Browser or GV-IP Device Utility	
Access from Web Browser	Live View, Video Recording, Change Video Quality, Bandwidth Control, Image Snapshot, Defog, Digital Zoom, Text Overlay, Image Masking	
Language	Czech, English, French, German, Hungarian, Italian, Japanese, Polish, Portuguese, Russian, Spanish, Traditional Chinese	
Web Interface		
Software Supported	GV-VMS (V17.4.1 / V18.2.1), GV-DVR / NVR (V8.9.1), GV-Control Center (V3.8.0), GV-Recording Server / Video Gateway (V2.0.0), GV-Edge Recording Manager Win version (V2.0.0), GV-Redundant / Failover Server (V1.2.0)	
Smart Device Access	GV-Eye for iOS and Android	
Live Viewing	Browser (IE, Edge, Chrome), Mobile App	









**Note:**

1. It is required to apply patch files to all or some of the supported software.
2. Do not use clothes or any ordinary material to clean the camera cover since they may result in scratches.
3. Specifications are subject to change without notice.

**Packing List**

- |                               |                          |
|-------------------------------|--------------------------|
| 1. GV-EBD8813 IR Eyeball Dome | 4. Drill Template Paster |
| 2. Waterproof Rubber Set      | 5. Download Guide        |
| 3. Screw kit                  | 6. Warranty Card         |

## Accessories

Model No.	Name		Details
GV-Mount107 (must be used with GV-Mount212P)	Pendant Bracket		Dimensions: Ø 120 x 334 mm (Ø 4.72" x 13.15") Weight: 0.74 kg (1.63 lb)
GV-Mount211P	Wall Mount and Junction Box		Dimensions: Ø 233 x 126 x 126 mm (Ø 9.2" x 5" x 5") Weight: 1 kg (2.2 lb)
GV-Mount212P	Wall Box Mount		Dimensions: Ø 126 x 36 mm (Ø 5.0" x 1.4") Weight: 0.22 kg (0.48 lb)
GV-Mount300-2	Convex Corner Mount		Dimensions: 137 x 233 x 160 mm (5.4" x 9.17" x 6.3") Weight: 1.65 kg (3.64 lb)
GV-Mount310-2	Concave Corner Mount		Dimensions: 111.2 x 369.9 x 210 mm (2.6" x 11.4" x 6.6") Weight: 1.65 kg (3.64 lb)
GV-Mount420 (must be used with GV-Mount211P)	Pole Mount Bracket		Dimensions: Ø 120 x 120 x 53.4 mm (Ø 4.7" x 4.7" x 2.1") Weight: 0.45 kg (0.99 lb) Steel Strap Diameter: Ø 67 ~ 127 mm (Ø 2.6" ~ 5")
GV-Mount704 (must be used with GV-Mount107)	Extension Tube		Dimensions: Ø 3.5 x 10 or 20 or 30 or 50 cm (Ø 1.38 x 3.9 or 7.9 or 11.8 or 19.7") Weight: 225 g or 360 g or 500 g or 780 g (0.5 lb or 0.79 lb or 1.1 lb or 1.72 lb)
GV-PA191	Power over Ethernet (PoE) Adapter		The GV-PA191 is a Power over Ethernet (PoE) adapter designed to provide power to the IP device through a single Ethernet cable.
GV-POE Switch	The GV-POE Switch is designed to provide power along with network connection for IP devices. The GV-POE Switch is available in various models with different numbers and types of ports.		
Power Adapter	Contact our sales representatives for the countries and areas supported.		