

GV-EVD5100 5MP H.264 Low Lux WDR IR Vandal Proof IP Dome



- 1/3.2" progressive scan low lux CMOS
- Dual streams from H.264 and MJPEG
- Up to 30 fps at 2592 x 1944
- Vandal resistance (IK10)
- Ingress protection (IP67)
- Intelligent IR
- Day and Night function (with removable IR-cut filter)
- Megapixel varifocal lens
- P-Iris lens for auto Iris control
- IR distance up to 30 m (98.4 ft)
- 3-axis mechanism (pan / tilt / rotate)
- DC 12V / PoE (IEEE 802.3af)
- Two-way audio
- Wide Dynamic Range (WDR)
- 3D noise reduction
- Defog
- Motion detection
- Tampering alarm
- Text overlay
- Privacy mask
- IP address filtering
- Supports iPhone, iPad, Android & 3GPP
- 31 languages on Web interface
- ONVIF (Profile S) conformant
- More storage option - [NAS](#)

Introduction

GV-EVD5100 is an outdoor camera designed with IK10 vandal resistance and IP67 ingress protection. The camera is featured with WDR, an automatic IR-cut filter and IR LEDs for day and night surveillance. Adjustable in 3 axis (pan, tilt and rotate), it offers an entry-level surveillance solution with all the essential features and excellent image quality.

Active Tampering Alarm

Tampered



Focus Change



Camera Shift

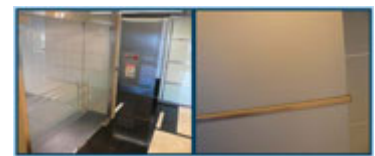

Dimensions

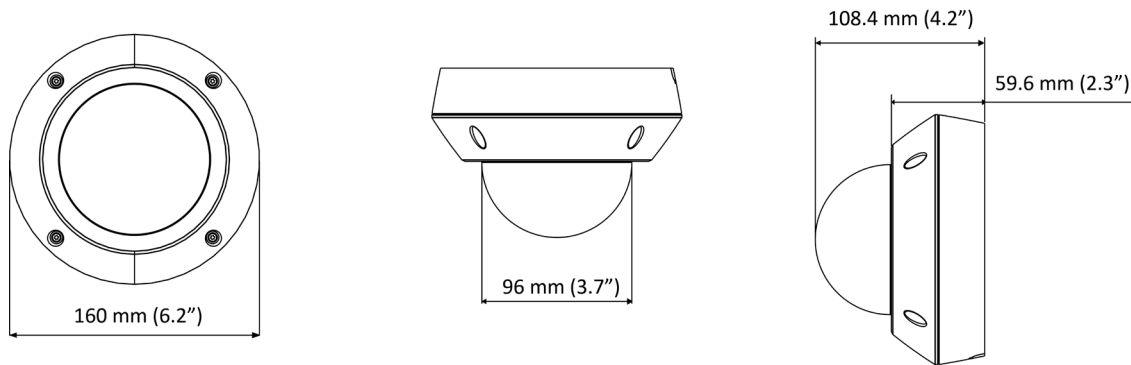

Specifications

Camera		
Image Sensor	1/3.2" progressive scan low lux CMOS	
Picture Elements	2592 (H) x 1944 (V)	
Minimum Illumination	Color	0.12 Lux
	B/W	0.10 Lux
	IR ON	0 Lux
Shutter Speed	Automatic, Manual (1/5 ~ 1/8000 sec.)	
White Balance	Automatic, Manual (2800K ~ 8500K)	
Gain Control	Automatic	
S/N Ratio	46 dB	
WDR	Yes	
Dynamic Range	Up to 72 dB	
Lens		
Megapixel	Yes	
Day/Night	Yes (with removable IR-cut filter)	
Focal Length	3 ~ 9 mm	
Lens Type	Varifocal	
Maximum Aperture	F/1.7	
Mount	Ø14 mm	
Horizontal FOV	92° ~ 32°	
Image Format	1/3.2"	
Operation	Focus	Manual (w/lock)
	Zoom	Manual (w/lock)
	Iris	P-Iris
Max. Torque (Focus / Zoom Screws)	0.049 N.m	
IR LED Quantity	20 IR LEDs	
Max. IR Distance	30 m (98.4 ft)	
Operation		
Video Compression	H.264, MJPEG	
Video Streaming	Dual streams from H.264 and MJPEG	
Frame Rate	30 fps at 2592 x 1944 (60/50 Hz) * The frame rate and the performance may vary depending on the number of connections and data bitrates (different scenes).	
Image Setting	Brightness, Contrast, Saturation, Sharpness, Gamma, White Balance, Flicker-less, Image Orientation, Shutter Speed, D/N Sensitivity, Backlight Compensation, WDR, Defog, Low Lux Enhancement, Noise Reduction	
Audio Compression	G.711, AAC (Optional)	
Audio Support	Two-way Audio	
Video Resolution		
Main Stream	4:3	2592 x 1944 (Default), 2048 x 1536, 1600 x 1200, 1280 x 960, 640 x 480, 320 x 240
	16:9	1920 x 1080, 1280 x 720, 640 x 360, 448 x 252
	5:4	1280 x 1024, 640 x 512, 320 x 256

Sub Stream	4:3	960 x 720 (Default), 640 x 480, 320 x 240
	16:9	640 x 360, 448 x 252
	5:4	640 x 512, 320 x 256
Network		
Interface	10/100 Ethernet	
Ethernet Protocol	DHCP, DynDNS, FTP, HTTP, HTTPS, IPv6, NTP, ONVIF (Profile S), PSIA, QoS (DSCP), RTSP, SNMP, SMTP, TCP, UDP, UPnP, 3GPP/ISMA	
Mechanical		
Temperature Detector	Yes	
Camera Angle Adjustment	Pan	0° ~ 350°
	Tilt	0° ~ 75°
	Rotate	0° ~ 340°
Connectors	Power	2-pin terminal block, PoE
	Ethernet	Ethernet (10/100 Base-T), RJ-45 cable
	Audio	1 In (microphone phone jack, 3.5 mm / 0.14") 1 Out (stereo phone jack, 3.5 mm / 0.14")
	TV-Out	BNC connector (D1 resolution)
LED Indicator	2 LEDs: Power, Status	
General		
Environment Temperature	Start-up	-20 °C ~ 50 °C (-4 °F ~ 122 °F)
	Operation	-30 °C ~ 50 °C (-22 °F ~ 122 °F)
Humidity	10% to 90% (no condensation)	
Power Source	12V DC / PoE (IEEE 802.3af)	
Max. Power Consumption	7 W	
Dimension	ø 160 x 108.4 mm (6.2 x 4.27")	
Weight	1.15 kg (2.54 lb)	
Ingress Protection	IP67	
Vandal Resistance	IK10	
Regulatory	CE, FCC, RCM, RoHS compliant	
Power over Ethernet		
PoE Standard	PoE (IEEE 802.3af Power over Ethernet / PD)	
PoE Power Supply Type	End-Span	
PoE Power Output	Per Port 48V DC, 350mA. Max. 15.4 watts	
Web Interface		
Installation Management	Web-based configuration	
Maintenance	Firmware upgrade through Web Browser or Utility	
Access from Web Browser	Camera Live View, Video Recording, Change Video Quality, Bandwidth Control, Image Snapshot, Audio, Picture in Picture, Picture and Picture, Privacy Mask, Text Overlay, Digital PTZ	
Language	Arabic / Bulgarian / Czech / Danish / Dutch / English / Finnish / French / German / Greek / Hebrew / Hungarian / Indonesian / Italian / Japanese / Lithuanian / Norwegian / Persian / Polish / Portuguese / Romanian / Russian / Serbian / Simplified Chinese / Slovakian / Slovenian / Spanish / Swedish / Thai / Traditional Chinese / Turkish	
Applications		
Network Storage	GV-System (GV-DVR/NVR), GV-Recording Server, GV-VMS	
Smart Device Access	GV-Eye for iOS and Android	
Live Viewing	Browser (IE, Chrome, Firefox, Safari), Mobile App	
CMS Server support	GV-Control Center, GV-Center V2, GV-Vital Sign Monitor	

Note:

- Specifications are subject to change without prior notice.
- When the resolution is set at 2592 x 1944:
 - If the camera is switched to single stream (while stream two is deselected) and Noise Reduction is disabled, the frame rate can reach up to 30 FPS.
 - If the camera is switched to dual streams and Noise Reduction is disabled, the frame rate can reach up to 25 FPS.
 - As long as Noise Reduction is enabled, whether the camera is switched to single stream or dual streams, the frame rate will be 15 FPS.





Packing List



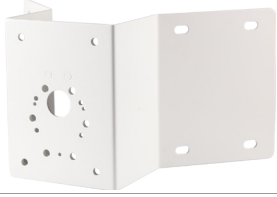
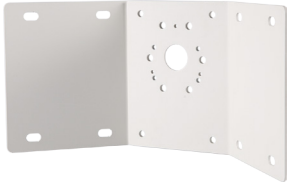

- | | |
|---|----------------------------------|
| 1. Target Vandal Proof Dome | 10. Torx Wrench |
| 2. Screw x 4 | 11. Big Concave hexagon Wrench |
| 3. Screw Anchor x 4 | 12. Small Concave hexagon Wrench |
| 4. TV-Out Wire | 13. Silica Gel Bag |
| 5. Audio Wires x 2 | 14. Sticker (for Silica Gel Bag) |
| 6. Installation Sticker | 15. Ruler |
| 7. Conduit Converter | 16. GV-IPCAM H.264 Software DVD |
| 8. RJ-45 Connector | 17. GV-NVR Software DVD |
| 9. Waterproof rubber sets
(for RJ-45 Cat.5 and 12V DC / for RJ-45 Cat.6) | 18. Warranty Card |

Note: Power adapters can be purchased upon request.

Accessories

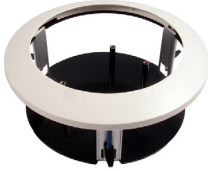
Model No.	Name		Details
GV-Mount100	Straight Tube and Junction Box Kit		Dimensions: 200 x 170 x 257.5 mm (7.9 x 6.7 x 10.1") Weight: 3.17 kg (6.99 lb)
GV-Mount101	Straight Tube Kit		Dimensions: 219 x 125 x 332 mm (8.6 x 4.9 x 13.1") Weight: 1.8 kg (3.97 lb)
GV-Mount200	Wall Pendant Tube		Dimensions: 225 x 140 x 250 mm (8.9 x 5.5 x 9.8") Weight: 900 g (1.98 lb)
GV-Mount203	Wall Pendant Tube and Junction Box Kit		Dimensions: 315 x 195.5 x 225 mm (12.4 x 7.7 x 8.9") Weight: 2.95 kg (6.5 lb)
GV-Mount206	Wall Mount Bracket Kit		Dimensions: 126.5 x 211.3 x 176.85 mm (5 x 8.3 x 6.96") Weight: 0.93 kg (2.06 lb)

Model No.	Name		Details
GV-Mount 208-2	Swan Neck Mount		Dimensions: 1043 x 519 x 256 mm (41.06 x 20.43 x 10.08") Weight 10.5 kg (23.15 lb)
GV-Mount300	Convex Corner Adapter Kit		Dimensions: 238.6 x 409.5 mm (9.4 x 16.1") Weight: 4.27 kg (9.41 lb)
GV-Mount310	Concave Corner Adapter Kit		Dimensions: 123.3 x 393.1 mm (4.9 x 15.5") Weight: 2.96 kg (6.53 lb)
GV-Mount400	Pole Mount Bracket Kit (\varnothing 4 ~ 6")		Bracket: 241 x 161 mm (9.5 x 6.3") Weight: 1.70 kg (3.75 lb) Steel Strap Diameter: \varnothing 4 ~ 6"
GV-Mount410	Pole Mount Bracket Kit (\varnothing 6 ~ 7.5")		Bracket: 241 x 161 mm (9.5 x 6.3") Weight: 1.70 kg (3.75 lb) Steel Strap Diameter: \varnothing 6 ~ 7.5"
GV-Mount702	Extension Tube		Four options are available. Dimensions: \varnothing 5.4 x 10 or 20 or 30 or 50 cm (\varnothing 2.1 x 3.9 or 7.9 or 11.8 or 19.7") Weight: 180 g or 390 g or 550 g or 800 g (0.4 lb or 0.86 lb or 1.21lb or 1.76 lb)
GV-Mount900	Wall Mount Bracket		Dimensions: 154 x 108 x 50 mm (6.1 x 4.3 x 2") Weight: 240 g (0.53 lb)

Model No.	Name	Details
GV-Mount903	GV-VD Series Dome Housing	 <p>Dimensions: Ø 186 x 97.5 mm (Ø 7.3 x 3.8") Weight: 600 g (1.32 lb)</p>
GV-Mount916	In-Ceiling Mount	 <p>Dimensions: Ø 205 x 63.8 mm (Ø 8 x 2.5") Weight: 645 g</p>
GV-PA191 PoE Adapter		 <p>Dimensions (H x W x D): 43 x 69 x 40 mm (1.69 x 2.72 x 1.57") Weight: 130 g (0.29 lb)</p>
Plastic PG21 Conduit Connector		 <p>The plastic PG21 conduit connector is used for running the wires of the camera through a 1/2" conduit pipe.</p>
Metal PG21 Conduit Connector		 <p>The metal PG21 conduit connector allows you to run the wires through a 3/4" conduit pipe.</p>
GV-POE Switch		<p>The GV-POE Switch is designed to provide power along with network connection for IP devices. The GV-POE Switch is available in various models with different numbers and types of ports.</p>
Power Adapter		<p>Contact your sales representative for the countries and areas supported.</p>