

GV-FER12203 12MP H.264 Low Lux Fisheye Rugged IP Camera



Introduction

GV-FER12203 is a 12 MP outdoor fisheye camera that allows you to monitor all angles of a location. It can be installed to the ceiling, wall, wall corner and the pole. The camera's distorted hemispherical image can be converted into a conventional rectilinear projection. Without installing any software, you can watch live view and utilize functions such as motion detection, privacy mask, and alert notification through the Web interface. In addition, the camera seamlessly integrates with the GV-System and GV-VMS, providing advanced monitoring and video management features.

Key Features

- 1/1.7" progressive scan CMOS
- Dual streams from H.264 and MJPEG
- Up to 15 fps at 4000 x 3000
- Day and night (with removable IR-cut filter)
- Intelligent IR
- Vandal resistance (IK10+ for metal casing)
- Ingress protection (IP67)
- 12V DC / 24V AC / PoE (IEEE 802.3at)
- Built-in microphone
- [Digital Object Tracking](#)
- Provides 360° and 180° panorama view
- Different angle of view accessible by multiple users at the same time
- Playback from any view angle and zoom level
- No mechanical moving parts
- Two-way audio
- Low lux enhancement
- 3D noise reduction
- USB slot for WiFi adapter
- One sensor input and alarm output
- Tampering alarm
- Virtual PTZ function
- Auto Pan function
- Privacy mask
- Visual automation
- Text overlay
- 31 languages on Web interface
- ONVIF (Profile S) conformant

* No Memory Card Slot & local storage function for Argentina.

Photos

Fisheye Source Image



Single View



2 x 180° View



360° View



Quad View



Dimensions

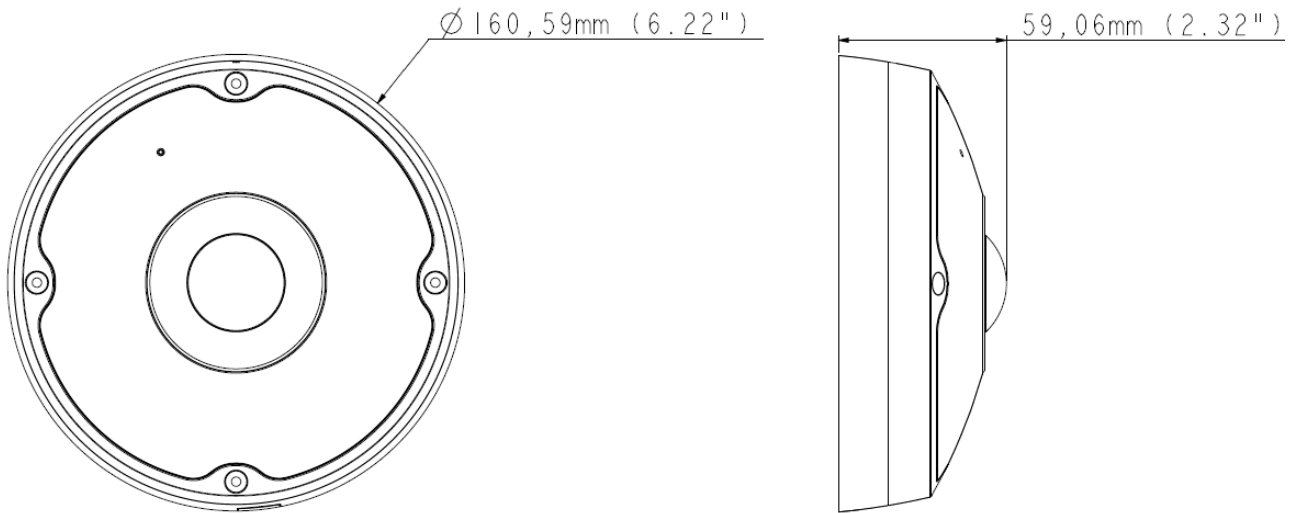

Specifications

System Requirements		
CPU	Intel Core i5-4670, 3.40 GHz	
Memory	DDR3 8 GB RAM	
On Board Graphics	Intel HD Graphics 4600 (Versions of driver from year 2014 or later required)	
Camera		
Image Sensor	1/1.7" progressive scan CMOS	
Picture Elements	4000 (H) x 3000 (V)	
Minimum Illumination	Color	0.1 Lux
	B/W	0.05 Lux
	IR On	0 Lux
Shutter Speed	Automatic, Manual (1/30 ~ 1/16000 sec.)	
White Balance	Automatic, Manual (2800K ~ 8500K)	
Gain Control	Automatic	
S/N Ratio	52 dB	
Optics Lens		
Megapixel	Yes	
Day/Night	Yes (with removable IR-cut filter)	
Lens Type	Fixed	
Focal Length	1.83 mm	
Maximum Aperture	F/2.4	
Mount	M12	
Image Format	1/1.7"	
Horizontal FOV	180°	
Operation	Focus	Fixed
	Zoom	Fixed
	Iris	Fixed
IR LED Quantity	6 IR LEDs	
Max. IR Distance	30 m (98.43 ft)	
Operation		
Video Compression	H.264, MJPEG	
Video Streaming	Dual streams from H.264 or MJPEG	
Frame Rate	15 fps at 4000 x 3000, 25 fps at 2896 x 2768 *The frame rate and the performance may vary depending on the number of connections and data bitrates (different scenes).	
Image Setting	Brightness, Contrast, Saturation, Sharpness, Gamma, White Balance, Flicker-less, Image Orientation,	

	Shutter Speed, D/N, Denoise, Low Lux Enhancement, Metering	
Audio Compression	G.711, AAC (optional)	
Audio Support	Two-Way Audio	
Sensor Input	1 input (Dry Contact)	
Sensor Output	1 Digital Output (200mA 5V DC)	
Video Resolution		
Main Stream	4:3	4000 x 3000
	20:19	2896 x 2768
Sub Stream	4:3	640 x 480
	20:19	640 x 608
Network		
Interface	10/100/1000 Ethernet	
Protocol	DHCP, DynDNS, FTP, HTTP, HTTPS, NTP, ONVIF (Profile S), PSIA, QoS (DSCP), RTSP, SMTP, SNMP, TCP, UDP, UPnP, 3GPP/ISMA	
Wireless LAN	IEEE 802.11 b/g/n	
Antenna Type	External	
Security	WEP, WPA-PSK(TKIP), WPA-PSK(AES), WPA2-PSK(TKIP), WPA2-PSK(AES)	
Mechanical		
Temperature Detector	Yes	
Connectors	Power	2-pin terminal block, PoE
	Ethernet	RJ-45
	Audio	1 In (Using the built-in microphone or externally connecting a microphone) 1 Out (Stereo phone jack, 3.5 mm / 0.14")
	Digital I/O	3-pin terminal block, pitch 2.5 mm (0.1")
	Auto Iris	None
	Local Storage	Micro SD card slot (SD/SDHC, SD version 2.0 only, Class 10) * SDXC and UHS-I card types are not supported. * Currently, the local storage function is not supported.
	USB	GV-WiFi Adapter or USB hard drive * Currently, the connection to USB hard drive is not supported.
General		
Operating Temperature	-40°C ~ 50°C (-40°F ~ 122°F)	
Humidity	10% to 90% (no condensation)	
Power Source	12V DC / 24V AC / PoE (IEEE 802.3at)	
Max. Power Consumption	28 W	
Dimension	Ø 160.6 x 59.1 mm m (6.32" x 2.33")	
Weight	700 g (1.54 lb)	
Ingress Protection	IP67	
Vandal Resistance	IK10+ for metal casing	
Regulatory	CE, FCC, RCM, LVD, RoHS compliant	
Power over Ethernet		
PoE Standard	PoE (IEEE 802.3at Power over Ethernet / PD)	
PoE Power Supply Type	End-Span	
PoE Power Output	Per Port 48V DC, 600mA. Max. 30 watts	
Web Interface		
Installation Management	Web-based configuration	
Maintenance	Firmware upgrade through Web Browser or Utility	
Access from Web Browser	Camera Live View, Video Recording, Change Video Quality, Bandwidth Control, Image Snapshot, Digital I/O Control, Audio, Picture in Picture, Picture and Picture, Motion Detection, Privacy Mask, Visual Automation, Tampering Alarm, Auto Pan Function, Virtual PTZ, Wide Angle Lens Dewarping, Text Overlay	
Language	Arabic / Bulgarian / Czech / Danish / Dutch / English / Finnish / French / German / Greek / Hebrew / Hungarian / Indonesian / Italian / Japanese / Lithuanian / Norwegian / Persian / Polish / Portuguese / Romanian / Russian / Serbian / Simplified Chinese / Slovakian / Slovenian / Spanish / Swedish / Thai / Traditional Chinese / Turkish	

Applications

Network Storage	GV-System (GV-DVR/NVR), GV-Backup Center, GV-Recording Server, GV-VMS
Live Viewing	IE, Mobile App
CMS Server Support	GV-Control Center, GV-Center V2, GV-Vital Sign Monitor

Note:

1. Specifications are subject to change without notice.
2. Do not use clothes or any ordinary material to clean the camera cover since they may result in scratches.
3. Mind the following when using an inserted memory card for recording:
 - Recorded data on the memory card can be damaged or lost if the data are accessed while the camera is under physical shock, power interruption, memory card detachment or when the memory card reaches the end of its lifespan. No guarantee is provided for such causes.
 - The stored data can be lost if the memory card is not accessed for a long period of time. Back up your data periodically if you seldom access the memory card.
 - Memory cards are expendable and their durability varies according to the conditions of the installed site and how they are used. Back up your data regularly and replace the memory card annually.
 - To avoid power outage, it is highly suggested to apply a battery backup (UPS).
 - For better performance, it is highly suggested to use Micro SD card of MLC NAND flash, Class 10.
 - Replace the memory card when its read/write speed is lower than 6 MB/s or when the memory card is frequently undetected by the camera.





Packing List





- | | |
|-----------------------------|---------------------------------|
| 1. Fisheye Camera | 9. Installation Sticker |
| 2. Back Plate | 10. Ruler |
| 3. Plate Screw x 3 | 11. Silica Gel Bag x 2 |
| 4. Plastic Screw Anchor x 3 | 12. Power Adapter |
| 5. Torx Wrench | 13. GV-IPCAM H.264 Software DVD |
| 6. RJ-45 Connector | 14. GV-NVR Software DVD |
| 7. Data Cable | 15. Warranty Card |
| 8. Terminal Block | |

Note: The power adapter can be excluded upon request.

Accessories

Model No.	Name		Details
GV-Mount100	Straight Tube and Junction Box Kit		Dimensions: 200 x 170 x 257.5 mm (7.9" x 6.7" x 10.1") Weight: 3.17 kg (6.99 lb)
GV-Mount101	Straight Tube Kit		Dimensions: 219 x 125 x 332 mm (8.6" x 4.9" x 13.1") Weight: 1.8 kg (3.97 lb)

Model No.	Name		Details
GV-Mount200	Wall Pendant Tube		Dimensions: 225 x 140 x 250 mm (8.9" x 5.5" x 9.8") Weight: 900 g (1.98 lb)
GV-Mount203	Wall Pendant Tube and Junction Box Kit		Dimensions: 315 x 195.5 x 225 mm (12.4" x 7.7" x 8.9") Weight: 2.95 kg (6.5 lb)
GV-Mount206	Wall Mount Bracket Kit		Dimensions: 126.5 x 211.3 x 176.85 mm / 5 x 8.3 x 6.96 in (L x W x diameter) Weight: 0.93 kg / 2.06 lb
GV-Mount300	Convex Corner Adapter Kit		Dimensions: 238.6 x 409.5 mm (9.4" x 16.1") Weight: 4.27 kg (9.41 lb)
GV-Mount310	Concave Corner Adapter Kit		Dimensions: 238.6 x 409.5 mm (9.4" x 16.1") Weight: 4.27 kg (9.41 lb)
GV-Mount400	Pole Mount Bracket Kit (Ø 4" ~ 6")		Bracket: 241 x 161 mm (9.5" x 6.3") Weight: 1.70 kg (3.75 lb) Steel Strap Diameter: Ø 4" ~ 6"
GV-Mount410	Pole Mount Bracket Kit (Ø 6" ~ 7.5")		Bracket: 241 x 161 mm (9.5" x 6.3") Weight: 1.70 Kg (3.75 lb) Steel Strap Diameter: Ø 6" ~ 7.5"
GV-Mount702	Extension Tube		Four options are available. Dimensions: Ø 5.4 x 10 or 20 or 30 or 50 cm (Ø 2.1" x 3.9" or 7.9" or 11.8" or 19.7") Weight: 180 g or 390 g or 550 g or 800 g (0.4 lb or 0.86 lb or 1.21 lb or 1.76 lb)

Model No.	Name	Details
GV-Mount903	Fisheye Dome Housing	 <p>Dimensions: Ø 186 x 97.5 mm (Ø 7.3" x 3.8") Weight: 700 g (1.54 lb)</p>
GV-Mount912	Power Box Mount Bracket	 <p>Dimensions: Ø 146 x 10.5 mm (Ø 5.7" x 0.4") Weight: 180 g (0.4 lb)</p>
GV-PA191	Power over Ethernet (PoE) Adapter	 <p>The GV-PA191 is a Power over Ethernet (PoE) adapter designed to provide power to the IP device through a single Ethernet cable.</p>
GV-POE Switch		<p>The GV-POE Switch is designed to provide power along with network connection for IP devices. The GV-POE Switch is available in various models with different numbers and types of ports.</p>
GV-WiFi Adaptor		 <p>Weight: 20 g (0.04 lb) Dimensions: 15 x 15 x 155 mm (0.59" x 0.59" x 6.10") Supplied with mini USB to standard USB adapter.</p>
Power Adapter		<p>Contact your sales representative for the countries and areas supported.</p>